



RETAIL **PARTS**

THIS SECTION IS ALSO
AVAILABLE ON
www.sealmaster.net

TABLE OF CONTENTS

Ball Valves / Gate Valves.....	3
Basket Strainers.....	4
Bearings, Seals, Plates, and Packing Glands	7
Billy Goat Blower Parts	9
Brush Water Box.....	10
Burner Assemblies	11
Clamp Coupling 2-Piece	13
CrackPro Applicator Wands/Shoes	14
Swivel Disk Applicators.....	16
Drag Brush Holders.....	22
Honda Engines	23
Hose Reels.....	23
Hydraulic Agitator Motors.....	24
Hydraulic Pumps & Mounts	25
Hydraulic Valves.....	27
Little Wonder Parts	28
Manhole Covers	29
Material Discharge Valves.....	31
Material Pumps	32
Rear Wheel Drive Motors.....	35
Sealer Discharge / Suction Hose	38
Seat.....	38
Spray Hoses & Wand	39
Sprockets	40
Squeegee Rubber.....	41
Surge Tanks	43
CrackPro Parts.....	44
Thermometers.....	45
Transmission	46
Towing Hitches	46
Water Pumps	47
Air Regulator Kits.....	48
Electric Hose Reel Kit	49
Manual Hose Reel Kit	51
Spray Bar Kit	52
Air Spray Bar Conversion Kit.....	54
Generator Conversion Kit.....	56
Spray Bar Kit / Tack Coat.....	58
Water System Kit Complete	60
Extended Deck Water System Kit Complete	62
Agitation Drive Kit [575 Gallon & Under]	64

Agitation Drive Kit [750-1500 Gallon]	66
CP Strobe Light Kit	68
CP 125HH Arrowboard Light & Mount Kit	70
CP 260/400HH Arrowboard Light & Mount Kit	72
CP Machines Strobe Light & Attachment Kit.....	74
Crack Pro Counter Balance Hose Boom Kit.....	76
Crack Pro Hose Guide Kit	78
Crack Pro End Support Kit	79
Crack Pro Side Chair Complete Assembly	80

BALL VALVES & GATE VALVES



Brass Ball Valves

PRODUCT #	DESCRIPTION	WEIGHT	PRICE
P397A009	1/2" [manual spray bar]	2 lbs.	\$15.00
P397A001	3/4" [SandPups]	3 lbs.	\$18.25
P397A013	1" [Hydraulic spray bars]	4 lbs.	\$29.75
P397A012	1 1/4" [Return Line Tanks]	2 lbs.	\$46.75
P397A002	2" [Material Lines]	6 lbs.	\$91.00
P397A008	3" Brass Ball Valve	18 lbs.	\$303.50

Carbon Steel Ball Valves

PRODUCT #	DESCRIPTION	WEIGHT	PRICE
P397A010	3/4" [wands]	2 lbs.	\$69.00
P397A006	1" [Hydraulic spray bars]	4 lbs.	\$79.50
P397A003	2" [Material lines]	8 lbs.	\$259.00



Brass Gate Valves

PRODUCT #	DESCRIPTION	WEIGHT	PRICE
P399A001	1/2" Brass Gate Valve	1 lbs.	\$17.00
P399A002	3/4" Brass Gate Valve	1 lbs.	\$18.00
P399A003	1" Brass Gate Valve	2 lbs.	\$18.25
P399A006	1 1/4" Brass Gate Valve	2 lbs.	\$ 30.00
P399A004	2" Brass Gate Valve	3 lbs.	\$ 85.75
P399A005	3" Brass Gate Valve	6 lbs.	\$ 255.00

BASKET STRAINERS



PRODUCT #	DESCRIPTION	WEIGHT	PRICE
P50313A	Basket Only - 1 Gallon - 1/8" holes	5 lbs.	\$143.50
P50313Q	Basket Only - 1 Gallon - 1/4" holes	5 lbs.	\$143.50
P50313XS	Basket Only - 1 Gallon - 1/16" holes	5 lbs.	\$143.50
P50313D	Basket Only - 1 Gallon Diamond Mesh	5 lbs.	\$143.50
P50313XL	Basket Only - 3 Gallon - 1/8" holes	7 lbs.	\$156.00
P50313XLQ	Basket Only - 3 Gallon - 1/4" holes	7 lbs.	\$156.00
P50313XLS	Basket Only - 3 Gallon - 1/16" holes	7 lbs.	\$156.00
P50313XLD	Basket Only - 3 Gallon Diamond Mesh	7 lbs.	\$156.00
P50313B	Basket Only - 1 Quart - 1/8" holes	2 lbs.	\$130.00
P50313BQ	Basket Only - 1 Quart - 1/4" holes	2 lbs.	\$130.00
P50313BXS	Basket Only - 1 Quart - 1/16" holes	2 lbs.	\$130.00
P50313M	GemSeal - 1 1/4 Gallon - 1/4" Holes	7 lbs.	\$194.25
P50313AB	Basket Only - Able - 1/8" holes	5 lbs.	\$150.50
P50313ABQ	Basket Only - Able - 1/4" holes	5 lbs.	\$150.50
P50313N	Basket Only - NEAL - 1/8" holes	2 lbs.	\$128.50
P50313NQ	Basket Only - NEAL - 1/4" holes	2 lbs.	\$128.50
P50313SR	Basket Only - SealRite - 1/8"	5 lbs.	\$173.75
P50313SRQ	Basket Only - SealRite - 1/4"	5 lbs.	\$173.75
1 Gallon Basket Only measures 6" high, 6 1/4" bottom diameter, 7 1/2" top diameter			
3 Gallon Basket Only measures 11 3/4" high, 6 1/4" bottom diameter, 7 1/2" top diameter			
1 Quart Basket Only measures 3 1/8" high, 3 3/8" bottom diameter, 4 1/2" top diameter			
Able Basket Only measures 5 7/8" high, 6 1/4" bottom diameter, 8 1/8" top diameter			
Neal Basket Only measures 5 1/8" high with a 3 3/8" diameter.			
SealRite Basket Only measures 6 1/4" high, 6 1/4" bottom diameter, 9" top diameter			

3 Gallon Basket Strainer Assembly [Complete]*

PRODUCT #	DESCRIPTION	WEIGHT	PRICE
P50147B005	3 Gallon Basket Strainer complete with 3" nipples [6 o'clock and 12 o'clock]	40 lbs.	\$795.00
P50147F005	3 Gallon Basket Strainer - 4800 Tanker	45 lbs.	\$795.50
3 Gallon Basket Complete measures 23" high with an 8" diameter.			
*When ordering Basket Strainer Complete, please specify the hole size for basket.			



1 Gallon Basket Strainer Assembly

PRODUCT #	DESCRIPTION	WEIGHT	PRICE
P50147B002	Housing, lid, & basket	30 lbs.	\$606.75
P50119A	Lid gasket for 1-gallon strainer and 3 gallon	2 lbs.	\$13.75
P50147D	1-gallon basket lid assembly and 3 gallon	8 lbs.	\$108.50

1 Quart Size Basket Strainer Assembly

PRODUCT #	DESCRIPTION	WEIGHT	PRICE
P50147B004	Housing, lid, & basket	12 lbs.	\$493.75
P50119B	Lid gasket - quart size	2 lbs.	\$13.75
P50147J	1-quart basket lid assembly with handle	4 lbs.	\$168.75
P50147I001	Locking handle Assy.	5 lbs.	\$103.25

BASKET STRAINER ASSY.

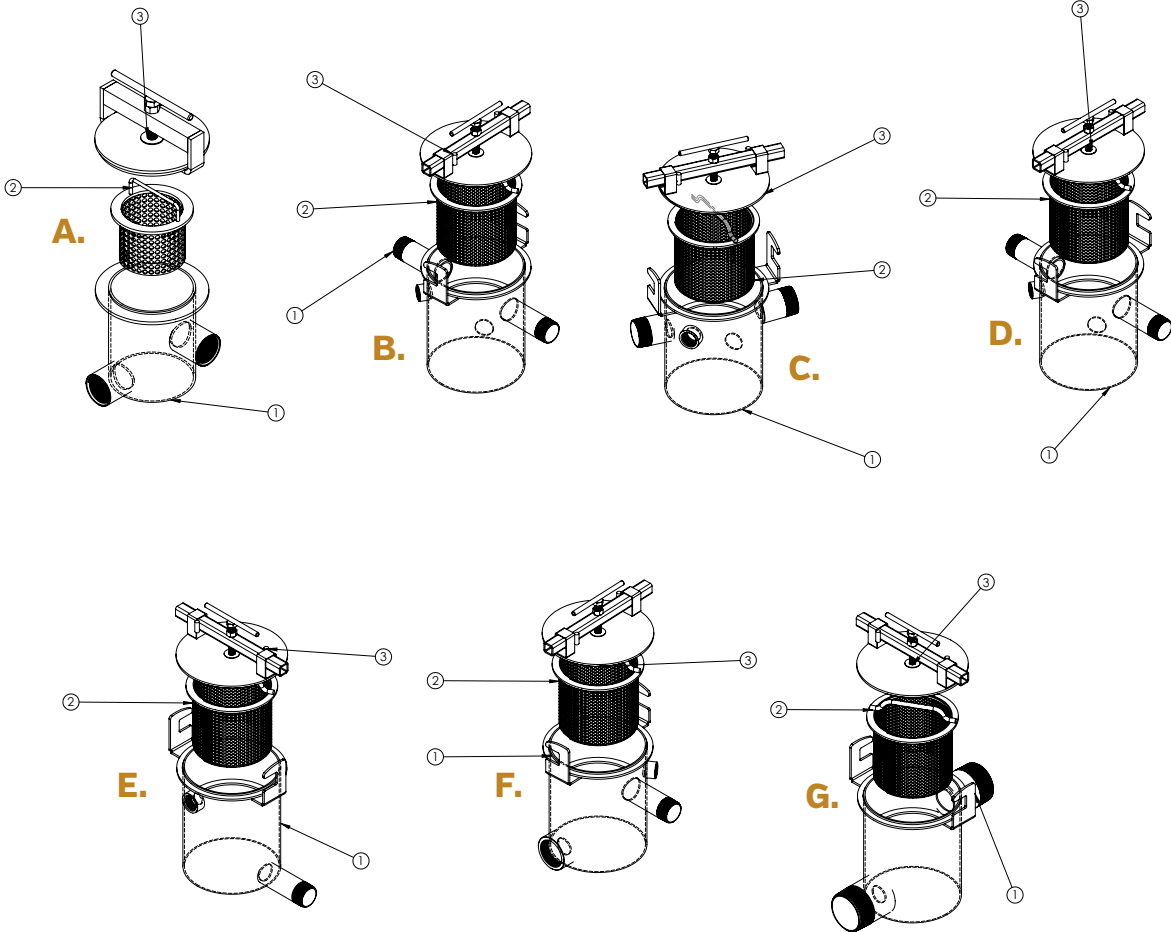

	PRODUCT #	DESCRIPTION	WEIGHT	PRICE
A.	P50147B007	Qt. Basket Strainer Assy. Tack Coat	12 lbs.	\$479.75
B.	P50147B008	Gallon Basket Strainer Assy. Trailer Mounts	30 lbs.	\$636.00
C.	P50147B009	Gallon Basket Strainer Assy. SP-300/575	30 lbs.	\$642.00
D.	P50147B010	Gallon Basket Strainer Assy. TR's W/2" Upgrade	30 lbs.	\$613.00
E.	P50147B011	Gallon Basket Strainer Assy. SandPup II	30 lbs.	\$622.75
F.	P50147B013	Gallon Basket Strainer Assy. Skids w/2" Upgrade	30 lbs.	\$642.00
G.	P50147B014	Gallon Basket Strainer Assy. 10K Master Mix	30 lbs.	\$622.75

BEARINGS, SEALS, PLATES, AND PACKING GLANDS



4-HOLE FLG.



2-HOLE FLG.

FLANGE BEARINGS



PILLOW BLOCK

Flange Bearings

PRODUCT #	DESCRIPTION	WEIGHT	PRICE
P432A001	3/4", 2-hole, 3 1/2" C to C	1 lb.	\$40.75
P432A002	1", 2-hole, 4" C to C	2 lbs.	\$21.50
P432A003	1 1/4", 2-hole, 5 1/8" C to C	3 lbs.	\$28.00
P434A002	1 1/4", 4-hole, 3 5/8" C to C	5 lbs.	\$26.75
P434A003	1 1/2", 4-hole, 4" C to C	6 lbs.	\$39.25
P434A004	2", 4-hole, 5 1/8" C to C	10 lbs.	\$68.25
P434A006	2 15/16", 4-hole, 6" C to C	29 lbs.	\$230.50
P434A001	1", 4-hole, 2 3/4" C to C	3 lbs.	\$23.50
P434A009	2", 4-hole, 5 1/4" C to C High Temp. Mastic Machine	10 lbs.	\$607.50

Pillow Block

PRODUCT #	DESCRIPTION	WEIGHT	PRICE
P435A003	1 1/4", 2-hole, 5" C to C	6 lbs.	\$36.25
P435A004	1 1/2", 2-hole, 5 1/2" C to C	6 lbs.	\$32.25
P435A005	2", 2-hole, 6 1/4" C to C	10 lbs.	\$85.75
P435A001	3/4", 2-hole, 4" C to C	3 lbs.	\$20.00
P435A002	1", 2-hole, 4 1/4" C to C	3 lbs.	\$28.25
P435A014	2 3/16", 2-hole, 7" C to C Mastic Machine	12 lbs.	\$117.00

2" PACKING GLAND

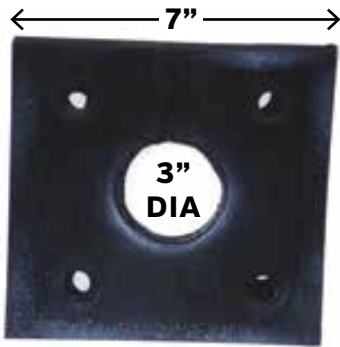

RUBBER AGITATOR SHAFT SEAL & BEARING PLATES



STEEL PACKING GLAND



Rubber Agitator Shaft Seal & Bearing Plates

PRODUCT #	DESCRIPTION	WEIGHT	PRICE
P50137B001	2" packing gland seal - rubber	4 lbs.	\$36.25
P50137B006	2" bearing plate - steel	4 lbs.	\$36.00
P50137B007	2" seal bearing plate - rubber	4 lbs.	\$35.75
P50137B002	1 1/2" seal bearing plate - rubber	3 lbs.	\$34.00
P50137B003	1 1/2" bearing plate - steel, 4-bolt hole	3 lbs.	\$35.25
P50137B004	1 1/4" bearing plate - steel, 4-bolt hole	3 lbs.	\$35.25
P50137B005	1 1/4" seal bearing plate - rubber	3 lbs.	\$31.00
P50137B010	2 15/16" packing gland seal - rubber	5 lbs.	\$43.50
P50137B011	2 15/16" bearing plate - steel	5 lbs.	\$42.00
P50137B012	2 15/16" seal bearing plate - rubber	5 lbs.	\$45.00
P50137B009	1 1/4" seal bearing plate [SP 300], 2-bolt hole - rubber	1 lb.	\$27.75
P50137B008	1 1/4" bearing plate - steel [SP 300], 2-bolt hole	2 lbs.	\$34.00
P74000B425	Rubber Seal - Agitator Crack Pro's 260 & 400	3 lbs.	\$36.75

Steel Packing Gland

PRODUCT #	DESCRIPTION	WEIGHT	PRICE
P50138B	2" packing gland weldment	18 lbs.	\$529.25
P50138D	2 15/16" packing gland weldment	20 lbs.	\$558.50
P50139C	2" packing gland kit	35 lbs.	\$605.00
P50139D	2 15/16" packing gland kit	40 lbs.	\$795.50
P638A006	1/4" mechanical packing	1 lb.	\$7.00/ft.

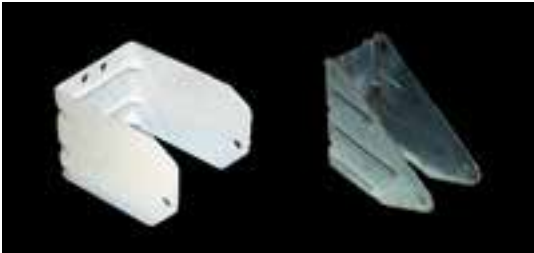
BILLY GOAT BLOWER PARTS

PRODUCT #	DESCRIPTION	BILLY GOAT PART #	WEIGHT	PRICE
				
P157A067	Front Wheel	900816	5 lbs.	\$47.75
				
P157A068	Front Wheel Bracket	430192	4 lbs.	\$46.75
P157A031	Rear Wheel [10"]	400295	5 lbs.	\$109.75
				
P157A069	Impeller Assembly	400965	16 lbs.	\$616.00
P157A027	Throttle Control Kit	400429	2 lbs.	\$59.75
P157A070	Throttle Control Kit	430199	2 lbs.	\$106.75
P157A072	Front Wheel-Pneumatic	430271	7 lbs.	\$139.75
P157A071	Front Wheel Bracket	430270	5 lbs.	\$49.75
P157A077	Cable Gust Control	430418	2 lbs.	\$54.75

BRUSH WATER BOX



PRODUCT #	DESCRIPTION	WEIGHT	PRICE
T1144	Brush Water Box - 40", 34.63 Gal	100 lbs.*	\$555.00
T1146	Brush Water Box - 55", 47.62 Gal	130 lbs.	\$648.00

*Oversized parts must ship at 30 lb. rate.

BURNER ASSEMBLIES

For SM-30s Before 2011 & Tack Machines
[300, 575, & 1500]



PRODUCT #	DESCRIPTION	WEIGHT	PRICE
P735A031	Burner Assembly Complete	9 lbs.	\$461.00
P662B003	Burner Plate	3 lbs.	\$82.25
P662A003	Burner Only	6 lbs.	\$259.00
P679A003	Thermocouple 24"	1 lb.	\$37.00
P735A015	Regulator	2 lbs.	\$67.25
P669A005	Hose - LP gas x 10 ft.	3 lbs.	\$61.25
P669B005	Hose - LP gas x 6 ft.	3 lbs.	\$51.50
P933A001	Pal-Nut	1 lb.	\$19.50
P935A001	Coupler - LP gas	1 lb.	\$15.75
P735A016	SM 30 Gas Valve	3 lbs.	\$70.25
P659A004	12" Stem Thermometer	2 lb.	\$99.25

For MA-10 Melter and SM-30 Melter [2011-Present]



PRODUCT #	DESCRIPTION	WEIGHT	PRICE
P670A004	MA-10 and SM-30 Torch Kit - Torch w/ 6 ft. Hose, Regulator and Ignitor	8 lbs.	\$216.00
P670A006	Torch Only	4 lbs.	\$124.75
P662A030	Valve/Orifice	1 lb.	\$58.75
P659A004	MA-10 Thermometer	2 lb.	\$99.25
P669B005	Propane Hose Assy x 6 ft.	3 lbs.	\$51.50
P735A015	Regulator	2 lbs.	\$67.25
P735A007	Gauge 0-60 PSI 1/4" Thread	1 lbs.	\$27.00

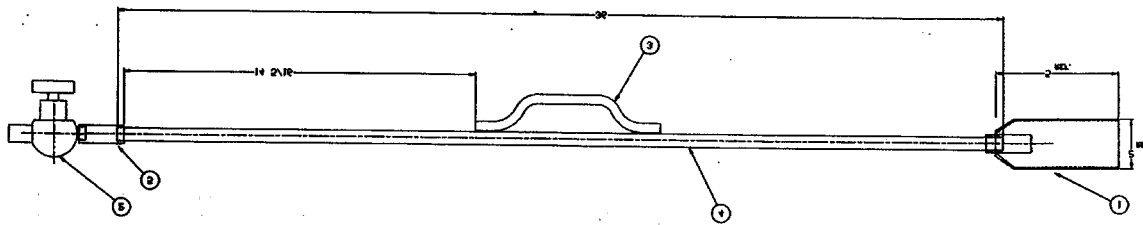

Hand Torch Assembly

PRODUCT #	DESCRIPTION	WEIGHT	PRICE
P75000B010	Hand Torch Assembly	4 lbs.	\$337.50

CLAMP COUPLING 2-PIECE



PRODUCT #	DESCRIPTION	KEYWAY SIZE	WEIGHT	PRICE
P498A001	1" to 1"	1/4" & 1/4"	5 lbs.	\$61.75
P498A002	1" to 1 1/16"	1/4" & 1/4"	5 lbs.	\$126.75
P498A003	1" to 1 1/8"	1/4" & 1/4"	5 lbs.	\$109.50
P498A004	1" to 1 1/4" Solid Coupling	1/4" & 3/8"	5 lbs.	\$167.00
P498A008	1" to 1 1/2"	1/4" & 1/2"	5 lbs.	\$133.25
P498A009	1 1/4" to 2" Solid Coupling	5/16" & 1/2"	5 lbs.	\$599.00
P498A010	1" to 1/2"	1/4" & 1/8"	5 lbs.	\$129.00
P498A011	1" to 5/8"	1/4" & 5/32"	5 lbs.	\$109.50
P498A012	1 1/4" to 1 1/4" Solid Coupling	5/16" & 3/8"	5 lbs.	\$185.25
P498A013	1" to 2" Solid Coupling	1/4" & 1/2"	5 lbs.	\$199.00
P498A014	1 7/16" to 5/8"	3/8" & 5/32"	5 lbs.	\$199.00
P498A015	1 7/16" to 1/2" Solid Coupling	3/8" x 1/8"	5 lbs.	\$289.75
P498A017	3/4" to 1/2" Solid Coupling	3/16" x 1/8"	5 lbs.	\$129.00

CRACKPRO APPLICATOR SHOES

PRODUCT #	DESCRIPTION	WEIGHT	PRICE
			
P163A009	Crack Sealing Square 3/4"	3 lbs.	\$187.75
P163C009	Crack Sealing Square 1/2"	3 lbs.	\$187.50
			
P163A012	Wand Shoe	4 lbs.	\$134.75
			
P163A005	Sealing Shoe	4 lbs.	\$154.25

PRODUCT #	DESCRIPTION	WEIGHT	PRICE
			
P163A057	Edge Joint Sealer Assy. 70 Deg. - Right	2 lbs.	\$111.25
			
P163A059	Edge Joint Sealer Assy. 70 Deg. - Left	2 lbs.	\$111.25

SWIVEL DISK APPLICATORS



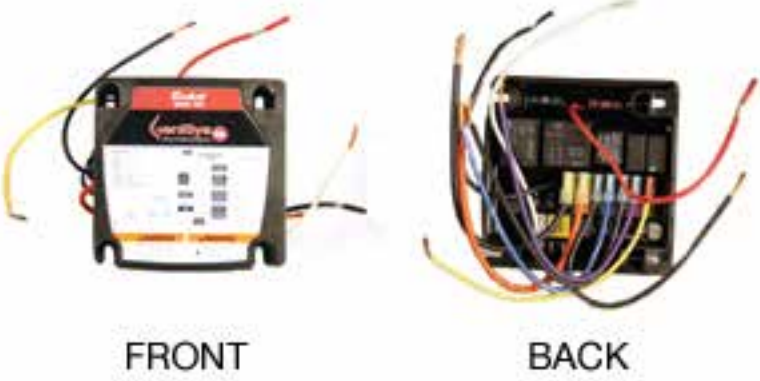

Available for CrackPro wands.

PRODUCT #	DESCRIPTION	WEIGHT	PRICE
P163A015	A) Guard-Duck Bill	1 lb.	\$19.75
P163A011	B) Duck Bill Valve	1 lb.	\$37.25
P470A002	C) Swivel Disc Only - 3"	2 lbs.	\$228.00
P470A003	Swivel Disc Only - 2"	3 lbs.	\$203.00
P470A007	Swivel Disc Only - 5"	3 lbs.	\$356.00
P470A008	Swivel Disc Only - 4"	6 lbs.	\$566.25
P470A001	Swivel Disc Applicator	3 lbs.	\$411.00
P470A004	Aluminum Body and Cap	2 lbs.	\$147.75
P470A010	Swivel Disc Only 3" [4" outside]	6 lbs.	\$561.50
P470C001	3" Swivel Disc [Straight]	6 lbs.	\$228.25

CrackPro 100, 125, 200, 250, & 400 with Pump System

PRODUCT #	DESCRIPTION	WEIGHT	PRICE
			
P662A043	A) Coil 12 Volt	1 lb.	\$29.00
P662A044	Motor Kit - includes motor / 1/2 shaft, wheel, and coupling	6 lbs.	\$195.75
P662A050	B) Cord Set	1 lb.	\$19.50
P662A052	Valve Stem	1 lb.	\$19.00
P662A019	C) Burner Tube Assembly	1 lb.	\$17.25
P662A051	D) Fuel Pump [CLEANCUT] - includes coil 12 volt, cord set, and burner tube assembly	4 lbs.	\$191.50
P662A009	Burner Assembly-complete	23 lbs.	\$1,119.00
			
P662A010	Burner Primary Artisan	4 lbs.	\$279.00

PRODUCT #	DESCRIPTION	WEIGHT	PRICE
			
P662A011	Burner Fuel Pump	4 lbs.	\$175.00
			
P662A046	Blower Wheel - Fits 1/2" Shaft	2 lbs.	\$30.50
			
P662A014	A) Cad Cell	2 lbs.	\$27.25
P662A015	B) Ignitor Transformer Assembly [Cad cell included]	2 lbs.	\$219.00

PRODUCT #	DESCRIPTION	WEIGHT	PRICE
			
P662A016	Burner Coupling - fits both motors	1 lb.	\$17.50
			
P662A017	Burner Nozzle / CP 125-260-400 2.25 x 90B	1 lb.	\$24.00
P662A060	Burner Nozzle / CP 60 Diesel 1.25 x 80A	1 lb.	\$24.00
P662A069	Burner Nozzle / SM-125 1.00 x 80B	1 lb.	\$24.00
			
P662A018	Burner Electrode	2 lbs.	\$49.00
			
P662A020	Oil Valve	1 lb.	\$99.00
P640A067	Material Pump [CP with Heated Hose]	75 lbs.	\$1,899.25
P640A040	Material Pump	91 lbs.	\$2,101.50

Non-Heated Hose

PRODUCT #	DESCRIPTION	WEIGHT	PRICE
P17582A004	Crackfilling Mat. Hose with Protective cover and hose ends	20 lbs.	\$1,990.00

Heated Hoses

PRODUCT #	DESCRIPTION	WEIGHT	PRICE
P17582B019	Heated Hose - 19 ft.	26 lbs.	\$4,747.00
P17582B023	Heated Hose - 23 ft.	27 lbs.	\$5,210.25
P17582A018	Crafco Heated Hose - 18 ft.	22 lbs.	\$4,083.00
P17582A020	Cimline Heated Hose - 20 ft.	22 lbs.	\$4,053.00
P17582K	CP 125 Heated Hose Conversion Kit	5 lbs.	\$167.50
P17582K2	CP 260/400 Heated Hose Conversion Kit	5 lbs.	\$167.50



P469A001	Applicator Head - 3"	2 lbs.	\$141.25
P469A002	Applicator Head - 5"	2 lbs.	\$142.25





P477A027	Female Disconnect	1 lb.	\$149.75
P477A028	Male Disconnect	1 lb.	\$60.00





P163A004 [A]	1/8" C/F Wand Tip [Has 3/4" NPT on end]	1 lb.	\$24.75
P163B004 [B]	3/8" C/F Wand Tip [Has 3/4" NPT on end]	1 lb.	\$21.75
P163C004 [C]	1/4" C/F Wand Tip [Has 3/4" NPT on end]	1 lb.	\$24.00

*Oversized parts must ship at 30 lb. rate.

PRODUCT #	DESCRIPTION	WEIGHT	PRICE
			
P399A003	Material Valve 1" Gate	2 lbs.	\$18.25
P399A020	Material Valve 1" Gate longstem	4 lbs.	\$123.25
P399A013	Material Valve 3" Steel Gate	12 lbs.	\$387.50
P652A002	Protective Sleeve Only [off the P17582A004]	1 lb.	\$299.00
P397A020	Wand Valve - Cold Pour	4 lbs.	\$241.75
P74000B001	Wand Valve with modified handle	4 lbs.	\$199.00
P397A010	Wand Valve	2 lbs.	\$69.00
			
P74000D000	CP Wand Alumn. Complete with Switch	34 lbs.	\$1,108.25
			
P632B000	Air Wand Assy. Sandpup II	5 lbs.*	\$234.25
			
P632C000	Air Wand Assy. 100 CFM Old Style	5 lbs.*	\$265.00
			
P632D000	Air Wand Assy. 100 CFM New Style	30 lbs.	\$239.25
P164B001 [A]	Air Lance Shoe	2 lbs.	\$86.25
			
P50273D	Cold Pour Wand	15 lbs.	\$612.50

*Oversized parts must ship at 34 lb. rate.

PRODUCT #	DESCRIPTION	WEIGHT	PRICE
			
P72000B102	Anti Rotational Fork (for cold pour wand)	2 lbs.	\$91.75
			
P74000B000	Crack Filling Wand	15 lbs.*	\$582.00

*Oversized parts must ship at 34 lb. rate.

DRAG BRUSH HOLDERS

For Squeegee Machines



PRODUCT #	DESCRIPTION	WEIGHT	PRICE
P29977C	72" Brush Holder	30 lbs.*	\$567.25
P29977D	96" Brush Holder	30 lbs.*	\$635.25
T1230	72" Drag Brush	5 lbs.	\$165.99
T1240	96" Drag Brush	6 lbs.	\$206.99

*Oversized parts must ship at 30 lb. rate. Brush sold separately.

HONDA ENGINES



PRODUCT #	DESCRIPTION	WEIGHT	PRICE
P458A080	GX 120 CC	42 lbs.	\$651.25
P458A022	GX 160 CC	35 lbs.	\$457.75
P458A027	GX 160 CC 6:1 Gear Reduction	50 lbs.	\$646.50
P458A074	GX 160 CC Electric Start	40 lbs.	\$766.50
P458A050	GX 240 CC	75 lbs.	\$1,142.50
P458A078	GX 270 CC	71 lbs.	\$792.00
P458A079	GX 340 XX	85 lbs.	\$853.00
P458A087	GX 390 CC 10 AMP Output	80 lbs.	\$1,098.00
P458A066	GX 690 CC	105 lbs.	\$2,382.00
P458A084	GX 690 CC with Controls Mounted	110 lbs.	\$2,606.50

HOSE REELS



PRODUCT #	DESCRIPTION	WEIGHT	PRICE
P901A001	Hose Reel - Manual	41 lbs.	\$630.25
P901A002	Hose Reel - Electric	80 lbs.	\$1,092.00

HYDRAULIC AGITATOR MOTORS

Agitator Drive Motor

PRODUCT #	DESCRIPTION	WEIGHT	PRICE
P474A088	Fits 12A, 72, bulk storage, 12-A Dual, 72 Dual	19 lbs.	\$512.50
P474A078	Fits pro-air & SandPumper II w/300-550 gallon tanks	23 lbs.	\$578.00
P474A017	Fits pro-air, maxx-air, econoline, Master Mix, & 750 gallon and up	35 lbs.	\$1,071.00
P474A056	Fits HD Bulk Tanks	29 lbs.	\$1,055.50
P474A042	Fits CrackPro 60 & 100 gravity flow units	21 lbs.	\$542.50
P474A037	Fits CrackPro 125 & 200	28 lbs.	\$1,052.00
P474A036	Fits CrackPro 400	34 lbs.	\$1,047.75
P474A049	Fits CrackPro 260 & 400 [2000 & up]	35 lbs.	\$1,096.25
			
P474A061	Fits SP 300 Agitator	23 lbs.	\$759.50
P474A063	Fits SP 575 Agitator	30 lbs.	\$1,116.50

Hot Oil Pump Motor

PRODUCT #	DESCRIPTION	WEIGHT	PRICE
P474A086	Fits CrackPro 200 & 400	21 lbs.	\$425.00

HYDRAULIC PUMPS & MOUNTS



PRODUCT #	DESCRIPTION	WEIGHT	PRICE
P474A026	Fits pro-air system 300-500 gallon (before 2003) [4-bolt flange]	8 lbs.	\$401.75
P601A041	Fits pro-air 575 and under (2003-present)	5 lbs.	\$265.75
P601A004	Fits bulk tanks w/electric motor	9 lbs.	\$475.00
P601A006	Fits bulk storage tanks with gas engines	9 lbs.	\$453.50
P601A007	Fits SandPumper 1 1/2" [all sizes]	17 lbs.	\$674.75
P601A035	Fits HD Bulk Tanks w/gas	14 lbs.	\$1,090.75
P601A038	Fits HD Bulk Tanks w/3" Bowie	8 lbs.	\$1,179.75
P601A040	Fits HD Bulk Tanks w/electric motor	8 lbs.	\$474.50
P601A014	Fits Pro-Air and Maxi Air 750 and up	9 lbs.	\$465.00

Pressure Compensated Hydraulic Pump

PRODUCT #	DESCRIPTION	WEIGHT	PRICE
P601A008	Fits SP 200 Dual, SP 300 Dual, SP 575 Dual SandPumper II tanks, 72 Dual Splined Shaft	19 lbs.	\$2,163.00
P601A010	Fits 12 A Dual, SandPumper II tanks	30 lbs.	\$4,779.00
P601A009	SandPumper II tanks - Keyed Shaft	30 lbs.	\$2,643.25

Tandem Gear Hydraulic Pump

PRODUCT #	DESCRIPTION	WEIGHT	PRICE
P601A018	Fits SP 200	15 lbs.	\$1,192.50

Gear Style Hydraulic Pump

PRODUCT #	DESCRIPTION	WEIGHT	PRICE
P601A020	Fits SP 300, SP 575 Econoline, Model 72	8 lbs.	\$451.00
P601A021	Fits SP 200 Dual	16 lbs.	\$473.00

Hydraulic Pump

PRODUCT #	DESCRIPTION	WEIGHT	PRICE
P601A023	Fits CrackPro 200 & 400	9 lbs.	\$466.00
P601A024	Fits CrackPro 200 & 400 with air compressor before 2010	16 lbs.	\$806.00
P601A044	Fits Crack Pro with Air Compressor 80 CFM after 2010	15 lbs.	\$792.75
P601A046	Fits Crack Pro with Air Compressor 100 CFM after 2010	15 lbs.	\$821.75

Hydraulic Pump Mounts



	PRODUCT #	DESCRIPTION	WEIGHT	PRICE
A.	P604A001	Pump Mount [13 HP Honda to SP Pump]	7 lbs.	\$123.50
	P604A002	Access Cover [for P604A001]	1 lb.	\$7.00
A.	P604A003	Pump Mount [8 HP Honda to Small Hyd. Pump]	5 lbs.	\$99.75
	P604A004	Access Cover [for P604A003]	1 lb.	\$6.50
B.	P29908B	Hyd. Pump Mount [Specify engine to Hyd. Pump and if going on compressor]	8 lbs.	\$465.00
A.	P604A014	Pump Mount 16 HP Vanguard to SP Pump	8 lbs.	\$132.00
A.	P604A015	Pump Mount 24 HP Honda to Transmission	8 lbs.	\$191.50
A.	P604A023	Pump Mount 23 HP Kohler to Transsion	8 lbs.	\$239.50
A.	P604A018	Pump Mount 5 HP Honda to Small Hyd. Pump	5 lbs.	\$121.75
A.	P604A010	Pump Mount 8 HP Honda to Large SP Pump	8 lbs.	\$122.25

HYDRAULIC VALVES

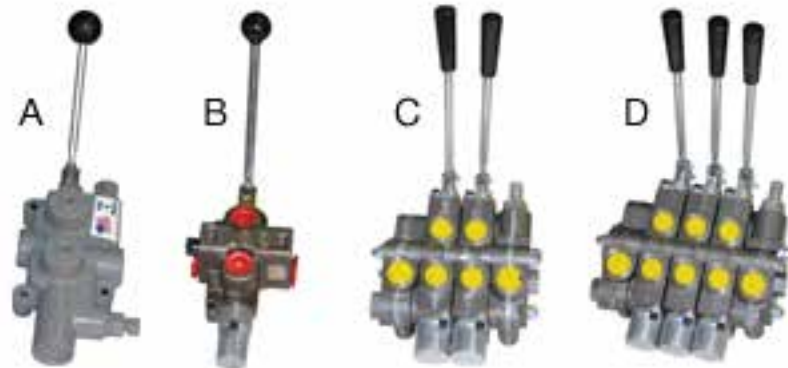

PRODUCT #	DESCRIPTION	WEIGHT	PRICE
P472A002	A) Squeegee Assembly lift valve - fits 12A, 72, SP 200, SP 300 econoline old style	7 lbs.	\$225.00
P472A016	B) Agitator Control Valve - Fits 12A, 72, SP 200, SP 300 Old Style, 12 A Dual, 72 Dual, CrackPro, bulk tanks, all air system tanks, SandPumper 1 1/2" tanks	9 lbs.	\$398.00
P472A005	B) FWD/REV Valve - fits 12A, SP 200, SP 200 Dual	9 lbs.	\$394.00
P472A011	B) Agitator Control Valve - fits SP 200 Dual, SP 300 Dual before bank valves, SandPumper II tanks	7 lbs.	\$219.75
P472A012	B) Squeegee Assembly lift valve - fits SP 200 Dual, SP 300 Dual Old Style	12 lbs.	\$214.75
P472A021	C) 2-Bank Valve SP 300 Econoline before Hydraulic Squeegee	21 lbs.	\$545.75
P472A022	C) 2-Bank Valve SP 300 Dual before Hydraulic Squeegee	21 lbs.	\$545.75
P472A019	D) 3-Bank Valve SP 575 Econoline & SP 300	26 lbs.	\$927.50
P472A027	D) 3-Bank Valve SP 575 Dual & SP 300 Dual	26 lbs.	\$927.50

LITTLE WONDER PARTS

Parts fit both old and new units.

PRODUCT #	DESCRIPTION	LITTLE WONDER PART #	WEIGHT	PRICE
				
P151A076	10" Front Wheel	4164205	4 lbs.	\$132.75
P151A077	10" Rear Wheel	4165974	4 lbs.	\$117.50
P151A078	12" Rear Wheel 13 HP	4164204	5 lbs.	\$132.75
				
P151A079	Throttle Cable - Honda	4166170-01	1 lb.	\$69.75
P151A080	Throttle Cable - Subaru	4166170-02	1 lb.	\$69.75
				
P151A081	Front Wheel Bracket	4165178.7	3 lbs.	\$69.75

MANHOLE COVERS

PRODUCT #	DESCRIPTION	WEIGHT	PRICE
			
P639A013	Manhole Assy. Coped w/Drip edge - 300 Gal. Tank	45 lbs.	\$812.50
P639A014	Manhole Assy. Coped w/Drip edge - 575 Gal. Tank	45 lbs.	\$819.00
P639A015	Manhole Assy. Coped w/Drip edge - 750 Gal. Tank	45 lbs.	\$812.50
P639A016	Manhole Assy. Coped w/Drip edge - 1000 & 1500 Gal. Tank	45 lbs.	\$812.50

PRODUCT #	DESCRIPTION	WEIGHT	PRICE
			
P639B005	Lid Manhole w/Vent - Drip Edge	25 lbs.	\$648.50
			
P639B004	Retaining Ring w/Splash Guard & Vent Hole	5 lbs.	\$233.00
			
P639A009	Gasket - Manhole Low Temp.	2 lbs.	\$25.75
P639R009	Gasket - Manhole - Rubber	2 lbs.	\$30.25
			
P639A006	Latch & Hardware	5 lbs.	\$171.75
			
P639A018	Vent - Mushroom - 3/4"	2 lbs.	\$38.75

MATERIAL DISCHARGE VALVES

Molasses Valve



PRODUCT #	DESCRIPTION	WEIGHT	PRICE
P585A002	3" Molasses Valve	8 lbs.	\$478.00
P586A	2" Molasses Valve	5 lbs.	\$89.00
P585B000	2" Molasses Valve [long handle] [SM-30]	5 lbs.	\$103.75
P585A004	1 1/2" Molasses Valve [long handle] [SM-10]	5 lbs.	\$97.25

Butterfly Valve



PRODUCT #	DESCRIPTION	WEIGHT	PRICE
P398A009	3" Butterfly Valve	15 lbs.	\$295.50
P398L009	3" Butterfly Valve - Left - SP Machine	15 lbs.	\$368.75
P398R009	3" Butterfly Valve - Right - SP Machine	15 lbs.	\$368.75

MATERIAL PUMPS

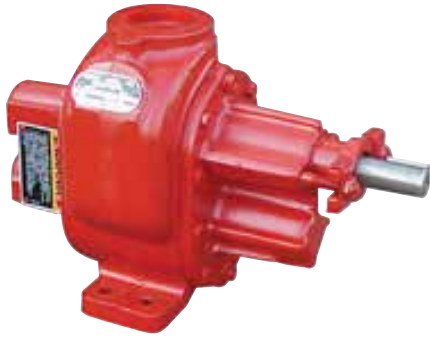

ROPER 3617



BOWIE 2400, 3300, 3400

Roper 3617

PRODUCT #	DESCRIPTION	WEIGHT	PRICE
P640A071	Steel Gear, 2"	91 lbs.	\$1,905.25
P640A084	Steel Gear 2" - Some Tack Coats	91 lbs.	\$1,528.50

Bowie 2400, 3300, 3400

PRODUCT #	DESCRIPTION	WEIGHT	PRICE
P640A030	Steel Gear, 2" [2400] Short Shaft	150 lbs.	\$3,893.00
P640A005	Rubber Gear, 2" [2400] Short Shaft	150 lbs.	\$3,259.75
P640A059	Steel Gear, 3" [3300] Long Shaft	150 lbs.	\$3,231.50
P640A025	Steel Gear, 3" [3400] Short Shaft	150 lbs.	\$4,346.75
P640A066	Rubber Gear, 3" [3300] Long Shaft	150 lbs.	\$2,345.75
P640A010	Rubber Gear, 3" [3400] Short Shaft	150 lbs.	\$3,921.50



ARO DIAPHRAGM PUMPS



SANDPUMPER II HYD DUAL DIAPHRAGM



ARO ASSEMBLY

ARO Diaphragm Pumps

PRODUCT #	DESCRIPTION	WEIGHT	PRICE
P640A060	ARO PD10A - 1" outlet	28 lbs.	\$1,039.75
P640A061	ARO PD15A - 1.5" outlet	60 lbs.	\$1,464.75
P640A068	ARO PD20A - 2" outlet	90 lbs.	\$1,567.75
P640A069	ARO PD30A - 3" outlet (Must ship LTL)	150 lbs.	\$2,657.25

SandPumper II Hyd Dual Diaphragm

PRODUCT #	DESCRIPTION	WEIGHT	PRICE
P640A024	2" outlet	195 lbs.	\$5,344.75

ARO Assembly



PRODUCT #	DESCRIPTION	WEIGHT	PRICE
P72000A002	ARO 1 1/2" Pump Assembly	70 lbs.	\$2,588.25
P72000D002	ARO 2" Pump Assembly	150 lbs.	\$2,690.75

Material Pump Rebuild Kits

PRODUCT #	DESCRIPTION	WEIGHT	PRICE
P972A038	Graco 2150 2" - Air Valve	3 lbs.	\$199.75
P972A039	Graco 2150 2" - Pump	3 lbs.	\$1,039.00
P971A038	Graco 1590 1 1/2" - Air Valve	3 lbs.	\$199.75
P971A039	Graco1590 1 1/2" - Pump	3 lbs.	\$869.00
P970A038	Graco 1040 1" - Air Valve	3 lbs.	\$199.75
P970A039	Graco 1040 1" - Pump	3 lbs.	\$534.00
P741A047	Bowie - Model 400 series	7 lbs.	\$879.00
P967A066	Wilden M-2	2 lbs.	\$353.50
P967A065	Wilden M-4	4 lbs.	\$374.25
P969A031	Wilden M-8	7 lbs.	\$408.00
P966A090	SandPumper II rebuild kit	11 lbs.	\$1,272.75
P966B090	SandPumper II material rebuild kit w/o seats	8 lbs.	\$618.50
P975A059	ARO 1" - Pump	2 lbs.	\$588.75
P976A059	ARO 1 1/2" - Pump	3 lbs.	\$669.75
P977A059	ARO 2" - Pump	5 lbs.	\$663.75
P975A060	ARO 1" - Air Valve Kit	1 lb.	\$142.00
P976A058	ARO 1 1/2" - Air Valve Kit	1 lb.	\$142.00
P977A058	ARO 2" & 3" - Air Valve Kit - A Style	1 lb.	\$210.50
P977B058	ARO 2" - Air Valve Kit [2010 to present] - B style	1 lb.	\$185.00
P978A001	ARO 3" - Pump Kit [Does not include seats]	8 lbs.	\$582.75
P978A002	Seats - 3" ARO [QTY. 4 Per Pump]	1 lb.	\$52.25 ea.

REAR WHEEL DRIVE MOTORS

Rear Wheel Drive Motor

PRODUCT #	DESCRIPTION	WEIGHT	PRICE
			
P578A006	Hub & Bearing Assembly	25 lbs.	\$1,762.75
			
P474A018	[Left] Hyd. Motor Rear Wheel Drive	30 lbs.	\$1,327.50
P474A019	[Right] Hyd. Motor Rear Wheel Drive	30 lbs.	\$1,327.50
			
P578A014	Hub-Tapered SP 575 - Front	9 lbs.	\$1,049.00
P474A079	Drive Motor - Front - SP 575	75 lbs.	\$875.00

PRODUCT #	DESCRIPTION	WEIGHT	PRICE
			
P474A080	Drive Motor - Rear - Left - SP 575	75 lbs.	\$1,023.75
P474A081	Drive Motor - Rear - Right - SP 575	75 lbs.	\$1,023.75
P474A082	Drive Motor - Rear - Right - SP 300	75 lbs.	\$860.75
P474A083	Drive Motor - Rear - Left - SP 300	75 lbs.	\$860.75
P474A066	Wheel Drive - Gear Unit - Front SP 575 [No brake]	75 lbs.	\$2,099.00
			
P474A068	Wheel Drive - Gear Unit - All SP's Rear	75 lbs.	\$2,399.00
			
P474B048	Hyd Motor & Hub Assembly SP 300 Rear Wheel Drive - Before current style	66 lbs.	\$2,871.50

PRODUCT #	DESCRIPTION	WEIGHT	PRICE
			
P474A059	Hyd Motor & Hub Assembly SP 575 Rear Wheel Drive	67 lbs.	\$4,790.00
			
P474A060	Fits SP 575 Front Drive	64 lbs.	\$2,120.00
P474A022	[Specify L or R] - fits SP 300, SP 300 Dual, 72, 72 Dual before 1998	61 lbs.	\$1,551.25
P474A020	[Specify L or R] - fits SP 200, SP 200 Dual, 12A, 12A Dual	31 lbs.	\$846.00

Material Pump Drive Motor

PRODUCT #	DESCRIPTION	WEIGHT	PRICE
P474A087	Fits bulk storage tanks w/Roper	18 lbs.	\$515.75
P474A089	CrackPro - Roper / 3" Bowie	21 lbs.	\$525.50

SEALER DISCHARGE / SUCTION HOSE



PRODUCT #	DESCRIPTION	WEIGHT	PRICE
P482A001	2" x 15' hose w/fittings	30 lbs.	\$250.75
P482A000	2" hose by the foot [no fittings]	3 lbs./ft.	\$15.00/ft.
P477A030	3/4" male quick disconnect	1 lb.	\$11.75
P477A031	3/4" female quick disconnect	2 lbs.	\$14.00
P477A010	2" male quick disconnect fitting	2 lbs.	\$14.00
P477A009	2" female quick disconnect fitting	3 lbs.	\$18.00
P482A002	3"x20' hose w/fittings	30 lbs.*	\$374.75

*Oversized parts must ship at 100 lb. rate.

SEAT



PRODUCT #	DESCRIPTION	WEIGHT	PRICE
P602A003	Seat	30 lbs.	\$114.25

*Oversized parts must ship at 30 lb. rate.

SPRAY HOSES & WAND



Hose with Fittings (wand sold separately)

PRODUCT #	DESCRIPTION	WEIGHT	PRICE
P754B025	3/4" x 50'	15 lbs.	\$191.75
P754B026	3/4" x 75'	21 lbs.	\$249.50
P754B027	3/4" x 100'	28 lbs.	\$317.50

Spray Wand with Ball Valve & Spray Tip

PRODUCT #	DESCRIPTION	WEIGHT	PRICE
P50273B	Spray wand with ball valve & spray tip	30 lbs.	\$196.50

Replacement Ball Valve for Spray Wand

PRODUCT #	DESCRIPTION	WEIGHT	PRICE
P397A010	3/4" carbon steel	2 lbs.	\$69.00

SPROCKETS



PRODUCT #	DESCRIPTION	WEIGHT	PRICE
P428A003	60B60 - 2" Bore - 4,000 & 6,000 gal bulk tanks	26 lbs.	\$199.00
P428A002	60B13 - 1" Bore - on bulk tanks	3 lbs.	\$27.00
P428A011	60B60 - 1 1/4" Bore - on bulk tanks	23 lbs.	\$240.50
P428A012	60B13 - 1 1/4" Bore - on bulk tanks	3 lbs.	\$30.50
P429A014	80R60 -10,000 gallon bulk tanks	50 lbs.	\$672.75
P740A012	Bushings - R1 x 2 15/16 for 80R60 and 80R96	8 lbs.	\$167.00
P429A006	80B12 - 1" Bore - 10,000 gallon bulk tank	5 lbs.	\$29.75
P429A020	80R96 - HD Bulk Tanks	125 lbs.	\$1,220.75
P429A019	80B60 - 1 1/2" Bore - 10,000 gallon bulk tanks	50 lbs.	\$459.00
P429A018	80B12 - 1 1/2" Bore - 10,000 gallon bulk tanks	5 lbs.	\$63.75
P429A017	80B12 - 1 1/4" Bore - HD Bulk Tanks	5 lbs.	\$38.00

RUBBER



NEOPRENE



TAN GUM

Squeegee Neoprene Rubber

PRODUCT #	DESCRIPTION	WEIGHT	PRICE
P459A028	3/8" x 5" x 50 ft.	56 lbs.	\$279.00
P459A002	3/8" x 5" x 72"	8 lbs.	\$45.50
P459A004	3/8" x 6" x 50 ft.	66 lbs.	\$308.00
P459A035	3/8" x 6" x 74"	9 lbs.	\$44.50
P459A003	3/8" x 6" x 90"	10 lbs.	\$54.00
P459A034	3/8" x 6" x 94"	11 lbs.	\$56.50
P459A025	1/2" x 5" x 50 ft.	76 lbs.	\$294.00
P459A001	1/2" x 5" Sold by the foot [up to 50 feet]	1.5 lbs./ft.	\$8.50/ft.
P459A017	1/2" x 5" x 32"	6 lbs.	\$21.50
P459A006	1/2" x 5" x 70"	9 lbs.	\$47.00
P459A007	1/2" x 5" x 72"	9 lbs.	\$48.25
P459A026	1/2" x 6" x 50 ft.	87 lbs.	\$374.00
P459A005	1/2" x 6" Sold by the foot [up to 50 feet]	1.8 lbs./ft.	\$10.00/ft.
P459A008	1/2" x 6" x 50"	8 lbs.	\$40.25
P459A023	1/2" x 6" x 74"	11 lbs.	\$59.75
P459A041	1/2" x 6" x 84"	13 lbs.	\$67.75
P459A009	1/2" x 6" x 90"	14 lbs.	\$72.50
P459A024	1/2" x 6" x 94"	14 lbs.	\$75.75
P459A033	1/2" x 6" x 106"	16 lbs.	\$85.50

Squeegee Gum Rubber

PRODUCT #	DESCRIPTION	WEIGHT	PRICE
P956A009	1/2" x 5" x 50 ft.	64 lbs.	\$1,774.00
P956A023	1/2" x 5" Sold per foot [up to 50 feet]	1.3 lbs./ft.	\$38.75/ft.
P956A022	1/2" x 5" x 48"	6 lbs.	\$148.25
P956A016	1/2" x 5" x 51"	6 lbs.	\$157.50
P956A010	1/2" x 5" x 70"	8 lbs.	\$216.00
P956A015	1/2" x 5" x 98"	11 lbs.	\$302.50
P956A014	1/2" x 5" x 110"	12 lbs.	\$339.50
P956A008	1/2" x 6" x 50 ft.	80 lbs.	\$1,799.00
P956A024	1/2" x 6" Sold per foot [up to 50 feet]	1.6 lbs./ft.	\$39.25/ft.
P956A012	1/2" x 6" x 90"	12 lbs.	\$282.00

Squeegee Kits

PRODUCT #	DESCRIPTION	WEIGHT	PRICE
P459A029	For SP300/SP300 Dual/SP575/SP575 Dual consists of: [1] - 1/2" x 6" x 74" Neoprene, [2] - 1/2" x 6" x 94" Neoprene	40 lbs.	\$199.00
P459A030	For SP200/SP200 Dual consists of: [1] - 3/8" x 6" x 70" Neoprene, [1] - 3/8" x 6" x 63" Neoprene, [1] - 3/8" x 6" x 75" Neoprene	30 lbs.	\$179.00
P459A031	For 12-A, 12-A Dual consists of: [2] - 1/2" x 5" x 70" Neoprene [1] - 1/2" x 5" x 70" Gum Rubber	30 lbs.	\$299.00
P459A032	For 72, 72 Dual consists of: [2] - 1/2" x 6" x 90" Neoprene [1] - 1/2" x 6" x 90" Gum Rubber	32 lbs.	\$349.00

Agitator Neoprene Rubber

PRODUCT #	DESCRIPTION	WEIGHT	QTY PER MACHINE	PRICE
P459A013	1/2" x 5" x 28" - SP 300 - 300 Tanks	6 lbs.	2	\$18.75 ea.
	575/750/1000 Tanks		3	
	SP 575 - 48" 1000		4	
P459A022	1/2" x 5" x 41 3/8" - 1,500 Tanks	8 lbs.	3	\$27.75 ea.
P459A046	1/2" x 5" x 52" - 2,000 Tanks	10 lbs.	3	\$35.00 ea.
P459A054	1/2" x 6" x 107" - 4800/5000 Tankers	20 lbs.	2	\$86.25 ea.
P459A047	1/2" x 6" x 101-1/2" - 6,000 Tanks	18 lbs.	2	\$81.75 ea.
P459A048	1/2" x 6" x 122-1/2" - 10,000 Tanks	23 lbs.	2	\$98.75 ea.
P459A055	1/2" x 6" x 125" - 12,000 Tanks	27 lbs.	2	\$100.50 ea.

Neoprene Rubber Clean Out Cover Seal

PRODUCT #	DESCRIPTION	WEIGHT	PRICE
P459A020	1/2" x 16" x 16" [No holes]	8 lbs.	\$60.00
P459A019	1/2" x 20" x 20" [No holes]	11 lbs.	\$108.75
P459A044	1/2" x 24" x 24" [No holes]	16 lbs.	\$122.50
P459A049	1/2" x 48" x 48" [No holes]	64 lbs.	\$399.00
P50229C002	1/2" x 20" x 20" [With holes] For 16" x 16" opening	11 lbs.	\$75.75
P50229F002	1/2" x 24" x 24" [With holes] For 20" x 20" opening	16 lbs.	\$156.00
P50229G002	1/2" x 28" x 28" [With holes] For 24" x 24" opening	19 lbs.	\$167.25

SURGE TANKS

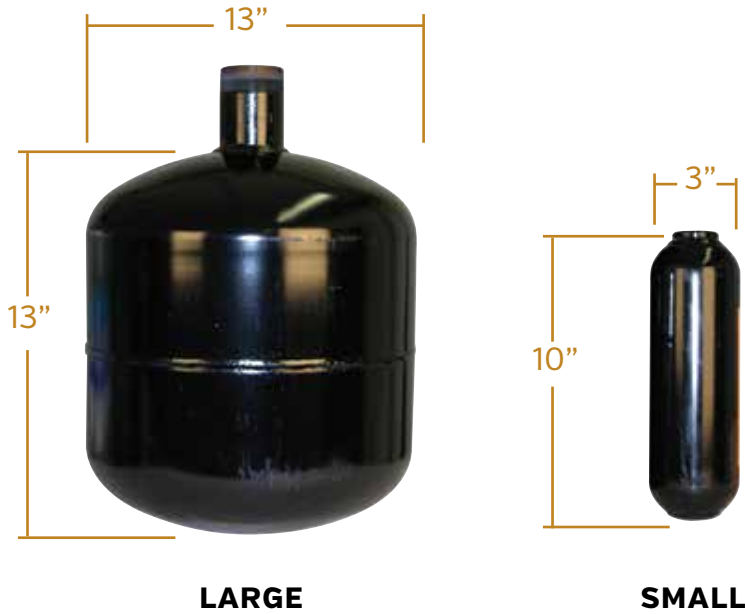

Large



PRODUCT #	DESCRIPTION	WEIGHT	PRICE
P30003F	Large Tank w/ 1 1/2" male thread	17 lbs.	\$230.75
P30003D	Large Tank w/ 2" male thread	17 lbs.	\$228.00
P30003G	Large Tank w/ 3" male threaded nipple	20 lbs.	\$255.75
P30003H	Large Tank w/ 4" male threaded nipple	22 lbs.	\$268.25

Small



PRODUCT #	DESCRIPTION	WEIGHT	PRICE
P30003E	SandPup, M-2 3/4" female thread	4 lbs.	\$120.50

CRACKPRO PARTS

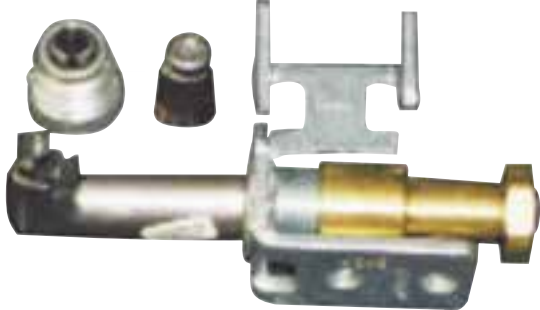
CrackPro 60 & 100 Gravity Flow

PRODUCT #	DESCRIPTION	WEIGHT	PRICE
 <p>1.) 2.)</p>			
P662B032	Burner - Double - CP100/125	19 lbs.	\$763.00
P662B030	Burner - Single	7 lbs.	\$532.50
P75000C028	Orifice/Burner CP60 [.1406]	1 lb.	\$18.25
P735E028	Orifice/Burner CP 100/125 [R.H./125]	1 lb.	\$18.25
P735F028	Orifice/Burner CP 100/125 [L.H./.0937]	1 lb.	\$18.25
P735A034	Regulator	3 lbs.	\$116.00
			
P735A036	Gas Valve	3 lbs.	\$494.75
			
P735A037	Pilot Light	1 lb.	\$102.25
P735A015	Regulator - Hand Torch	2 lbs.	\$67.25

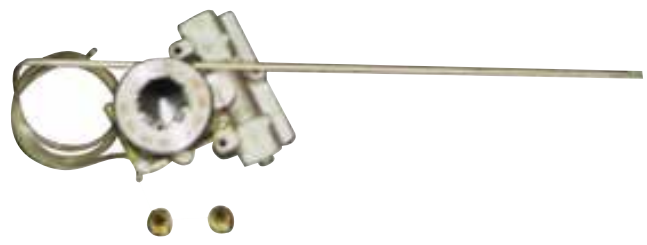
THERMOMETERS

PRODUCT #	DESCRIPTION	WEIGHT	PRICE
			
P659A001	B) 2 1/2" top mount	2 lbs.	\$74.25
P659A004	A) 12" side mount	2 lbs.	\$99.25
P659A010	B) 12" top mount	2 lbs.	\$99.25
P659A009	A) Thermometer - 18" side mount	3 lbs.	\$122.75
P659A008	A) 24" side mount	3 lbs.	\$170.50
P659A005	A) 36" side mount	3 lbs.	\$215.75
P679A005	Thermocouple 34"	2 lbs.	\$123.00
P679A008	Thermocouple 18" - hot oil jacket	1 lb.	\$102.75
P679A014	Thermocouple 24"	2 lbs.	\$109.00
P679A015	Thermocouple 30"	2 lbs.	\$122.25
P679A017	Thermocouple 23"	2 lbs.	\$103.00
			
P735A035	Temperature Control (Propane)	2 lbs.	\$468.50
P735A043	Temperature Control (Diesel)	2 lbs.	\$1,404.00
P735A061	Temperature Control - CrackPro Heated Hose	25 lbs.	\$2,445.75
			
P679A006	Thermopile	1 lb.	\$115.75

TRANSMISSION



P707A002



P707A012

PRODUCT #	DESCRIPTION	WEIGHT	PRICE
P707A002	Fits Model 72, 72 Dual, SP 300, SP 300 Dual before 1998	36 lbs.	\$4,999.00
P707A012	SP 300, SP 300 Dual - 2008 to present	40 lbs.	\$3,375.00
P707A011	SP 575 Dual & Econoline	69 lbs.	\$3,999.00

TOWING HITCHES





PINTLE EYE COUPLER



BALL HITCH COUPLER

PRODUCT #	DESCRIPTION	WEIGHT	PRICE
P646A003	Pintle Eye Coupler	20 lbs.	\$81.50
P553A008	2 5/16" Ball Hitch Coupler	20 lbs.	\$189.00

WATER PUMPS

PRODUCT #	DESCRIPTION	WEIGHT	PRICE
			
P593A051	North Star Electric - 12V, DC	7 lbs.	\$235.75
			
P471A001	Hypro hydraulic	28 lbs.	\$1,911.00

AIR REGULATOR KITS



PRODUCT #	DESCRIPTION	WEIGHT	PRICE
P735A046	Filter/Regulator - Short Kit (used with 1" pump)	2 lbs.	\$149.50
P735A047	Filter/Regulator - Long Kit (used with 1 1/2" pump)	3 lbs.	\$151.00
P709C000	Air Line	1 lb./ft.	\$2.75/ft.

ELECTRIC HOSE REEL KIT

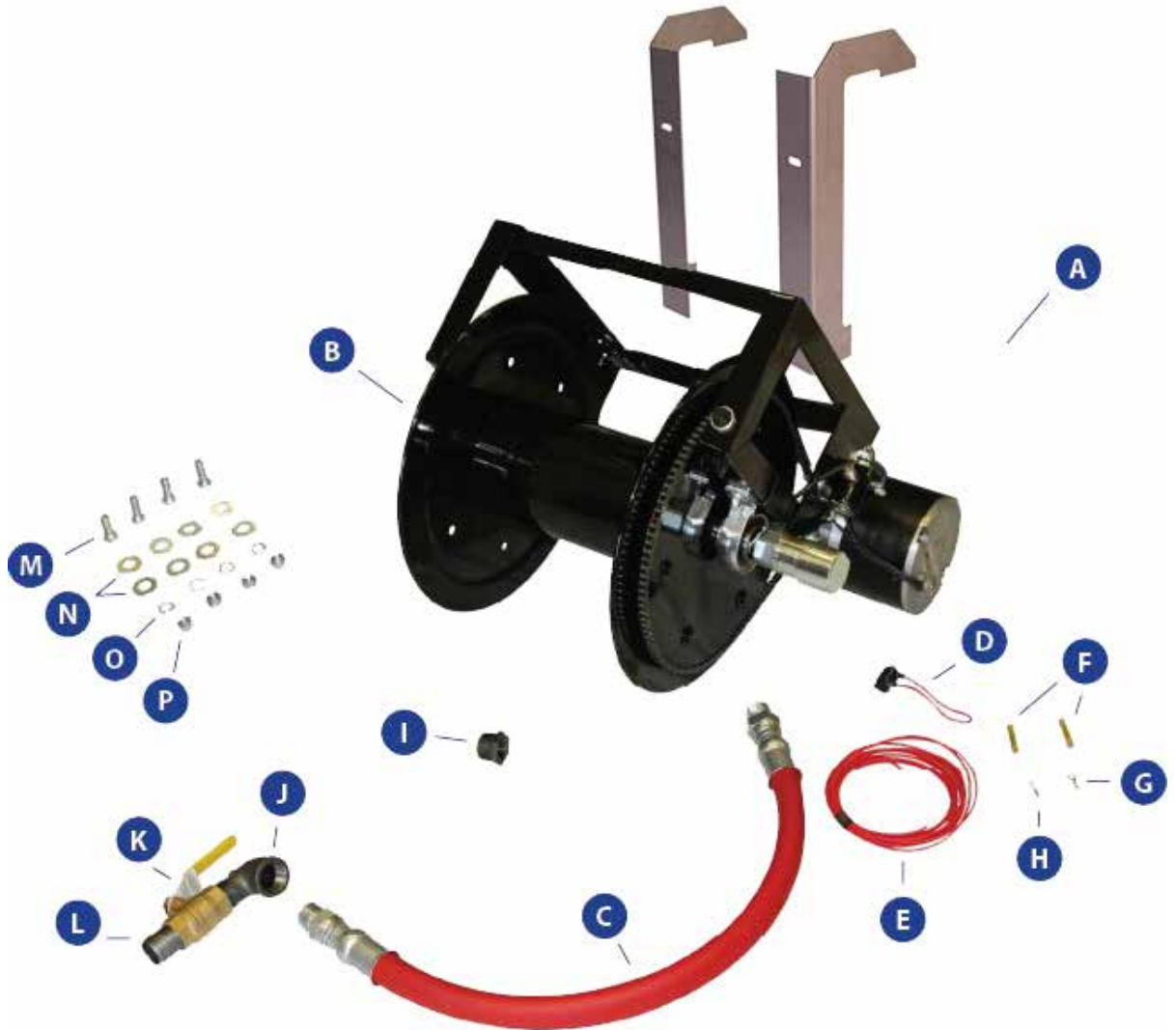

ELECTRIC HOSE REEL KIT

PRODUCT #	DESCRIPTION	QTY	PRICE
P50251K	Electric Hose Reel Kit [Specify Tank Size]	1	\$1,510.50
A P72000B087	Hose Reel Bracket	1	\$99.00
B P901A002	Electric Hose Reel	1	\$1,092.00
C P754B040	Hose Assembly - 575/750 Gallon	1	\$149.00
C P754C040	Hose Assembly - 1000/1500 Gallon	1	\$159.00
D P914A005	Circuit Breaker - 40 AMP	1	\$61.75
E P475B025	8 GA Ground Lug - 1/4"	1	\$9.00
F P475B026	8 GA Ground Lug - 5/16" [\$10.50 ea.]	3	\$31.50
G P475B027	8 GA GPT Wire [\$2.75/ft.]	22 ft.	\$60.50
H P1010A009	Reducing Bushing - 1" x 3/4"	1	\$4.75
I P1007A004	90° Street Elbow - 1"	1	\$10.50
J P397A013	Brass Ball Valve - 1"	1	\$29.75
K P1000A016	Pipe Nipple - 1" Close	1	\$4.00
L P1014A017	Cap Screw - 3/8" - 16 x 1" [\$.50 ea.]	4	\$2.00
M P1017A003	Flat Washer - 3/8" [\$.25 ea.]	8	\$2.00
N P1021A001	Lock Nut - 3/8" - 16 [\$.25 ea.]	4	\$1.00
O P555A002	Butt Terminal - 12-10	1	\$1.75
P901A016	Elbow Swivel - 1"	1	\$138.75

MANUAL HOSE REEL KIT

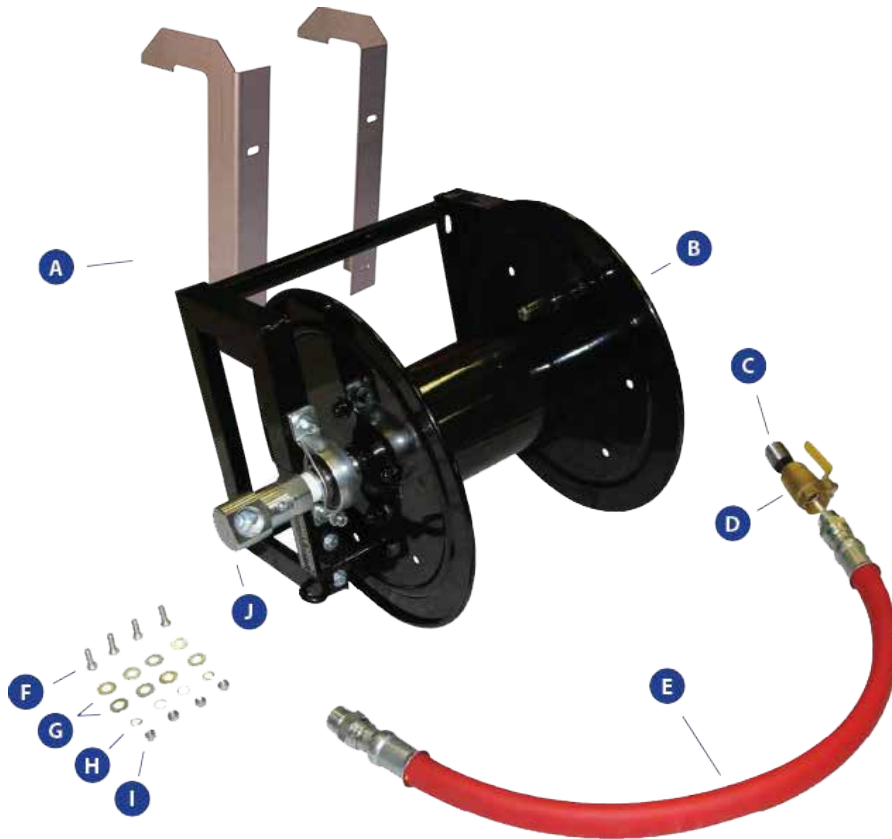

PRODUCT #	DESCRIPTION	QTY	PRICE
P50250K	Manual Hose Reel Kit [Specify Tank Size]	1	\$924.00
A P72000B087	Hose Reel Bracket	1	\$99.00
B P901A001	Manual Hose Reel	1	\$630.25
C P1000A016	Pipe Nipple - 1" Close	1	\$4.00
D P397A013	Brass Ball Valve - 1"	1	\$29.75
E P754B040	Hose Assembly - 575/750 Gallon	1	\$149.00
E P754C040	Hose Assembly - 1000/1500 Gallon	1	\$159.00
F P1014A017	Cap Screw - 3/8" - 16 x 1" [\$.50 ea.]	4	\$2.00
G P1017A003	Flat Washer - 3/8" [\$.25 ea.]	8	\$2.00
H P1021A001	Lock Nut - 3/8" - 16 [\$.25 ea.]	4	\$1.00
I P1010A009	Reducing Bushing - 1" x 3/4"	1	\$4.75
J P1007A004	90° Street Elbow - 1"	1	\$10.50
K P901A016	Elbow Swivel - 1"	1	\$138.75

SPRAY BAR KIT

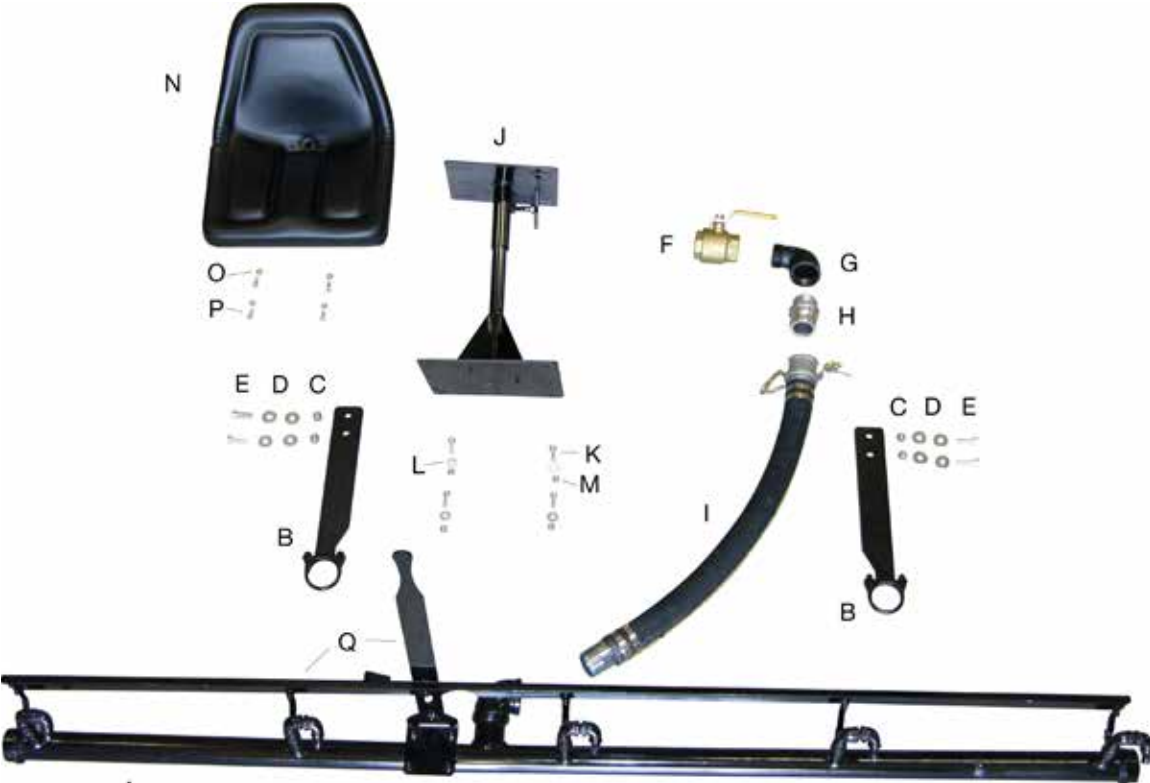

SPRAY BAR KIT

PRODUCT #	DESCRIPTION	QTY	PRICE
P50246MK	Spray Bar Kit (Without Lever)	1	\$1,385.00
A P50246AW	Manual Spray Bar Assembly & Weld	1	\$715.00
B P71000B001	Spray Bar Bracket [\$86.75 ea.]	2	\$173.50
C P1021A002	Lock Nut - 1/2" - 13 [\$0.50 ea.]	4	\$2.00
D P1017A005	Flat Washer - 1/2" [\$0.50 ea.]	8	\$4.00
E P1014A033	Cap Screw - 1/2" - 13 x 1-1/2" [\$1.25 ea.]	4	\$5.00
F P397A002	Brass Ball Valve - 2"	1	\$91.00
G P1007A007	90° Street Elbow - 2"	1	\$18.00
H P477A001	Hose Adapter - 2" Insert x 2" M NPT	1	\$14.00
J P72000B001	Seat Bracker Assembly	1	\$236.75
K P1014A018	Cap Screw - 3/8" - 16 x 1-1/4" [\$0.75 ea.]	4	\$3.00
L P1017A003	Flat Washer - 3/8" [\$0.25 ea.]	4	\$1.00
M P1021A001	Lock Nut - 3/8" - 16 [\$0.25 ea.]	4	\$1.00
N P602A003	Seat	1	\$114.25
O P1018A002	Lock Washer - 5/16" [\$0.25 ea.]	4	\$1.00
P P1014A009	Cap Screw - 5/16" - 18 x 1" [\$0.50 ea.]	4	\$2.00
P1017A002	Flat Washer - 5/16" [\$0.25 ea.]	4	\$1.00
Specify Which Discharge Hose You Want Included With Your Kit			
I P482B007	Discharge Hose - 2" x 5 ft. with Fittings for Truck Mounts and Some TR750's	1	\$149.00
I P482F007	Discharge Hose - 2" x 4 ft. with Fittings for Trailer Mounts	1	\$139.00
Q P50247LK	Lever for Manual Spray Bar Kit	1	\$412.50

AIR SPRAY BAR CONVERSION KIT

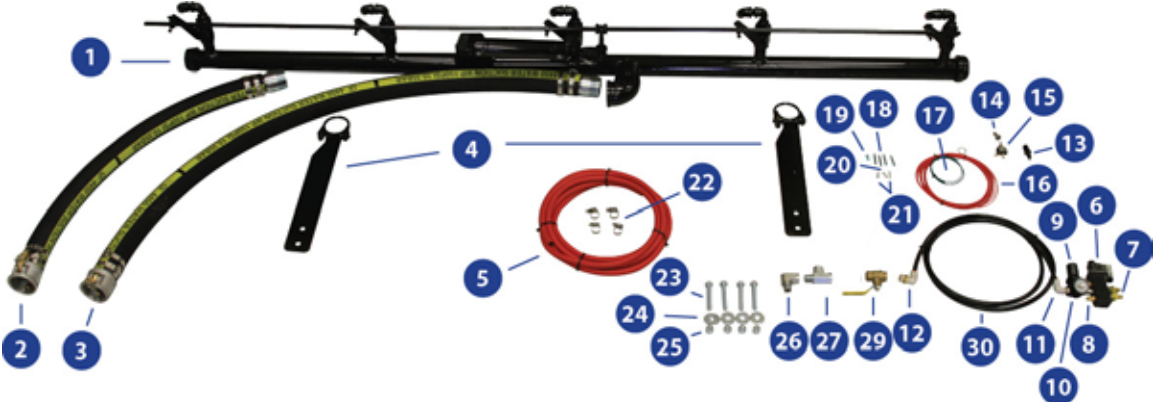

AIR SPRAY BAR CONVERSION KIT

PRODUCT #	DESCRIPTION	QTY	PRICE
P50246K	Air Spray Bar Kit	1	\$2,613.25
1	P50246AAW Manual Spray Bar Assembly & Weldment	1	\$2,030.00
2	P71000B001 Spray Bar Bracket [\$86.75 ea.]	2	\$173.50
3	P717E000 Air Line - 3/8" [\$5.75/ft.]	20 ft.	\$115.00
4	P600A025 Valve - Air	1	\$149.00
5	P751A002 Brass Hose End - 3/8" Hose Insert x 1/4" M NPT [\$3.25 ea.]	4	\$13.00
6	P600A027 Air Muffler [\$8.75 ea.]	2	\$17.50
7	P735A023 Regulator with Gauge	1	\$24.00
8	P735A027 Replacement Gauge for Regulator	1	\$16.25
9	P560A055 90° Brass Push-to-Connect Air Fitting - 1/2" x 1/4" M NPT	1	\$11.50
10	P560A045 90° Brass Push-to-Connect Air Fitting - 1/2" x 3/4" M NPT	1	\$15.00
11	P461A001 Fuse Holder	1	\$12.75
12	P443A004 Toggle Boot	1	\$14.00
13	P443A001 Toggle Switch - Single Pole	1	\$15.00
14	P556A017 Wire - 14 GA GXL - Red - Power [\$1.00]	20 ft.	\$20.00
15	P556A015 Wire - 14 GA GXL - Green - Ground [\$1.00]	2 ft.	\$2.00
16	P555A001 Butt Connector - 16-14 GA [\$1.75 ea.]	4	\$7.00
17	P491A003 Female Quick Disconnect - 16-14 GA	1	\$1.50
18	P491A001 Female Quick Disconnect - 16-14 GA	1	\$1.50
19	P554A001 Ring Terminal - 16-14 GA [\$1.50 ea.]	2	\$3.00
20	P1023A002 Hose Clamp - #6 [\$2.00 ea.]	4	\$8.00
21	P1054A001 Cap Screw - 1/2" - 13 x 3" - All Thread [\$2.50 ea.]	4	\$10.00
22	P1017A005 Flat Washer - 1/2" [\$.50 ea.]	8	\$4.00
23	P1021A002 Locknut - 1/2" - 13 [\$.50 ea.]	4	\$2.00
24	P560A016 1/2" Hydraulic 90° Street Elbow	1	\$10.75
25	P560A025 1/2" Hydraulic M x F x F Tee	1	\$15.25
26	P397A009 Brass Ball Valve - 1/2"	1	\$15.00
27	P709C000 Air Line - 1/2" [\$2.75/ft.]	8 ft.	\$22.00
28	P560A006 Hydraulic Adapter - 1/4" M NPT x 1/4" M NPT	1	\$1.75
Specify Which Discharge Hose You Want Included With Your Kit			
29	P482B007 Discharge Hose - 2" x 5 ft. with Fittings for Truck Mounts	1	\$149.00
30	P482F007 Discharge Hose - 2" x 4 ft. with Fittings for Trailer Mounts	1	\$139.00

GENERATOR CONVERSION KIT

To replace the new generator from the old generator on Crack Pro units.



GENERATOR CONVERSION KIT

PRODUCT #	DESCRIPTION	QTY	PRICE
P695B005	Generator Conversion Kit	1	\$1,439.00
A P695A005	Generator with Pulley	1	\$1,362.25
B P747A001	Polyloom - 3/8" [\$1.75/ft.]	2 ft.	\$3.50
C P716A000	Fuel Line - 5/16" [\$3.75/ft.]	3 ft.	\$11.25
D P556A017	Wire - 14 GA GXL - Red [\$1.00]	2 ft.	\$2.00
E P555A001	Butt Connector - 16-14 GA [\$1.75 ea.]	5	\$8.75
F P1014A011	Cap Screw - 5/16" - 18 x 1-1/2"	1	\$0.50
G P1014A009	Cap Screw - 5/16" - 18 x 1"	1	\$0.50
H P1021A005	Lock Nut - 5/16" - 18 [\$.25 ea.]	2	\$0.50
I P1017A002	Flat Washer - 5/16" [\$.25 ea.]	4	\$1.00
J P1014A001	Cap Screw - 1/4" - 20 x 1" [\$.25 ea.]	2	\$0.50
K P1021A006	Lock Nut - 1/4" - 20 [\$.25 ea.]	2	\$0.50
L P1017A001	Flat Washer - 1/4" [\$.25 ea.]	4	\$1.00
M P1014A019	Cap Screw - 3/8" - 16 x 1-1/2" [\$.75 ea.]	2	\$1.50
N P1017A003	Flat Washer - 3/8" [\$.25 ea.]	4	\$1.00
O P1021A001	Lock Nut - 3/8" - 16 [\$.25 ea.]	2	\$0.50
Specify Which V-Belt You Want Included With Your Kit			
P P660A049	V-Belt - Crack Pro with Air [\$30.25 ea.]	2	\$60.50
P P660A041	V-Belt - Crack Pro without Air [\$16.75 ea.]	2	\$33.50

SPRAY BAR KIT/TACK COAT

Spray Bar comes with 1/4" 80/20 Spray Tips

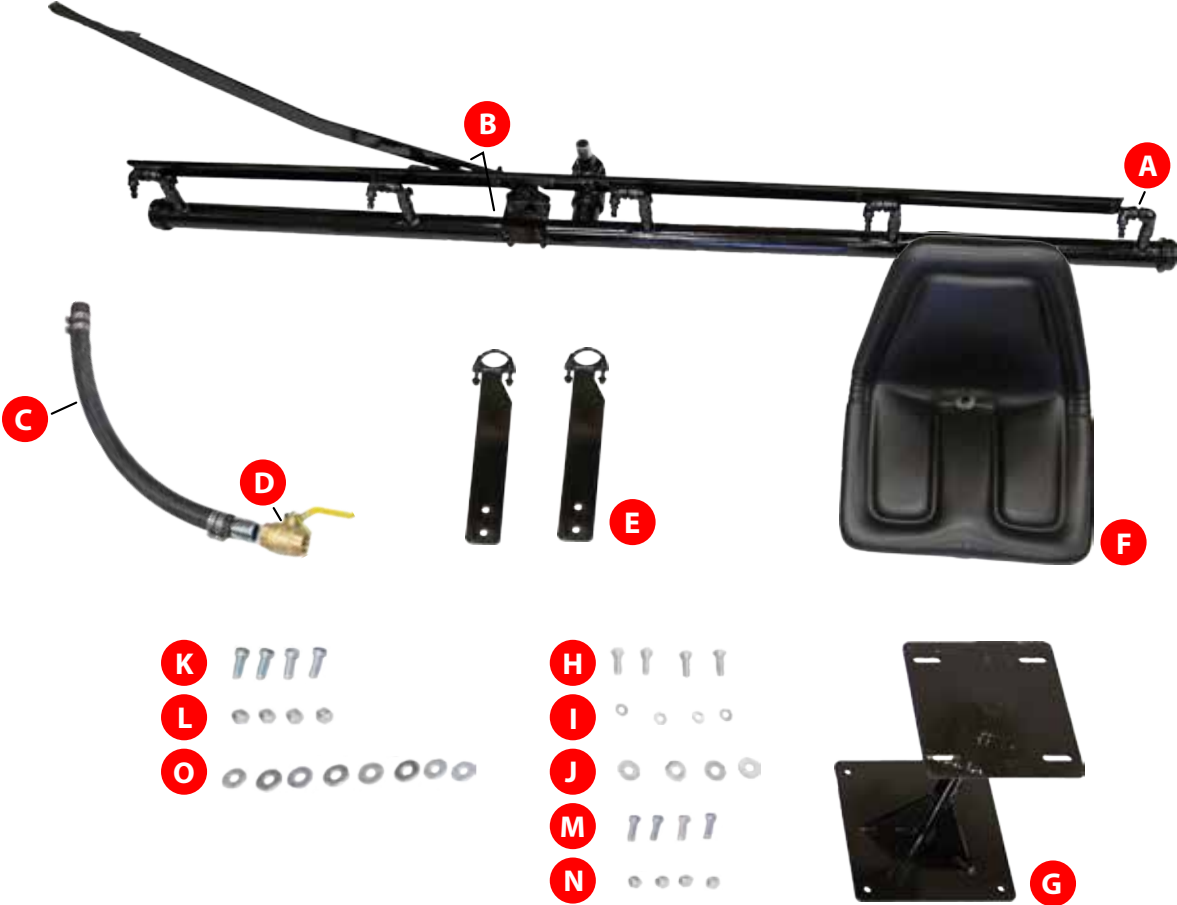

SPRAY BAR KIT/TACK COAT

PRODUCT #	DESCRIPTION	QTY	PRICE
P50246TK	Tack Coat Spray Bar Kit (Without Lever)	1	\$1,288.25
A P50246TAW	Hot Tack Manual Spray Bar Assembly	1	\$726.50
C P482A017	Suction Hose Assembly - 1-1/4" x 3 ft.	1	\$97.50
D P397A012	Brass Ball Valve - 1-1/4"	1	\$46.75
E P71000B001	Spray Bar Bracket [\$86.75 ea.]	2	\$173.50
F P602A003	Seat	1	\$114.25
G P72000B001	Seat Bracket Assembly	1	\$236.75
H P1014A009	Cap Screw - 5/16" - 18 x 1" (\$.50 ea.)	4	\$2.00
I P1017A003	Flat Washer - 3/8" (\$.25 ea.)	4	\$1.00
J P1018A002	Lock Washer - 5/16" - 18 (\$.25 ea.)	4	\$1.00
K P1014A033	Cap Screw - 1/2" - 13 x 1-1/2" [\$1.25 ea.]	4	\$5.00
L P1021A002	Lock Nut - 1/2" - 13 (\$.50 ea.)	4	\$2.00
M P1014A018	Cap Screw - 3/8" - 16 x 1-1/4" (\$.75 ea.)	4	\$3.00
N P1021A001	Lock Nut - 3/8" - 16 (\$.25 ea.)	4	\$1.00
O P1017A005	Flat Washer - 1/2" (\$.50 ea.)	8	\$4.00
B P50246LTK	Lever Kit - Tack Coat	1	\$361.50

WATER SYSTEM KIT COMPLETE

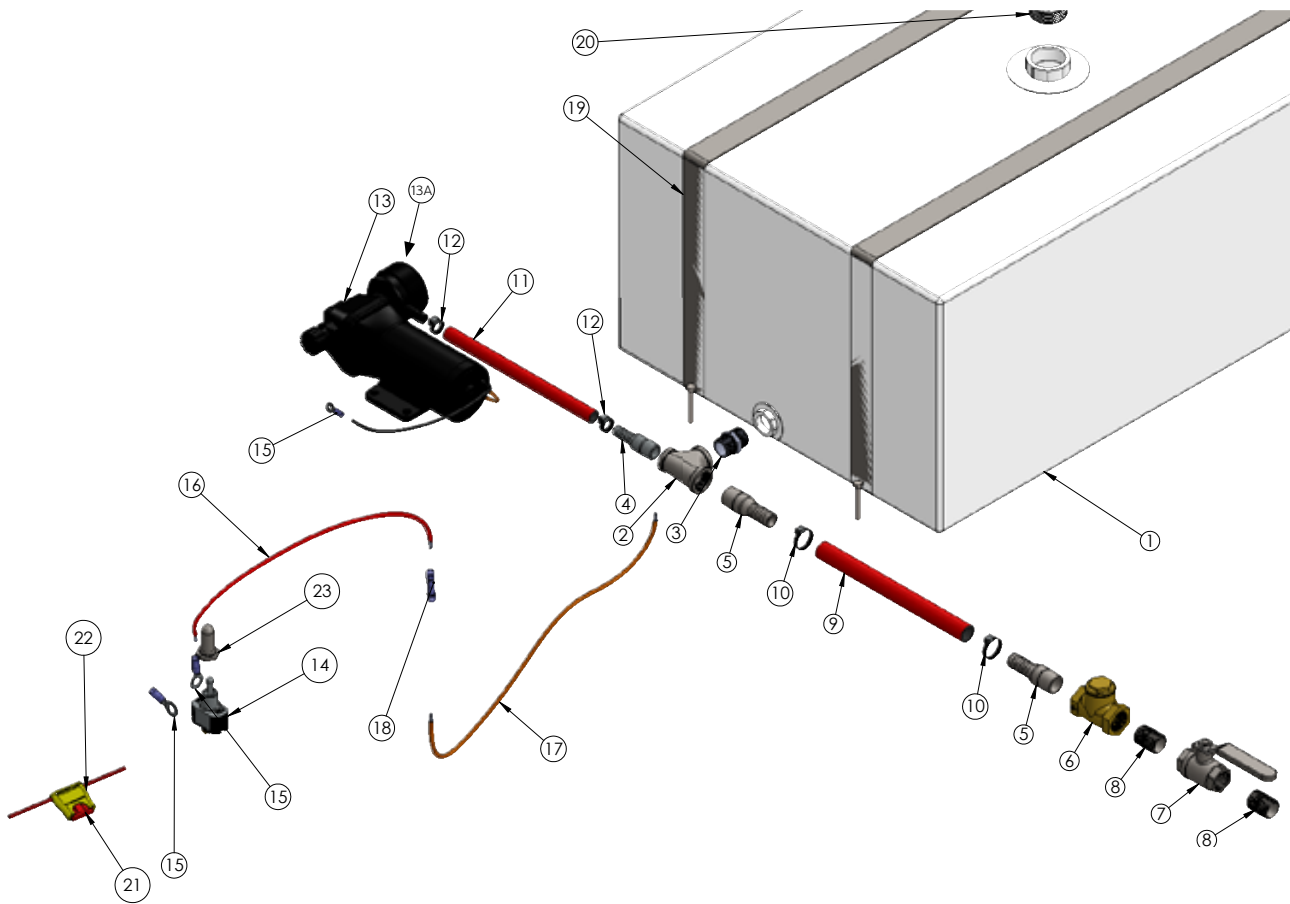

PRO AIR WATER SYSTEM KIT COMPLETE

PRODUCT #	DESCRIPTION	QTY	PRICE
P50330K	Water System Kit Complete	1	\$908.50
1	P593A051 Water Pump - 12V DC	1	\$235.75
2	P1005A012 Nylon Tee - F x F x F - 1/2"	1	\$14.25
3	P1007A012 90° Nylon Street Elbow - 1/2"	1	\$9.75
4	P1000A084 1/2" Nipple - Nylon	1	\$2.00
5	P1010A044 3/4" x 1/2" Threaded Bushing Reducer PVC	1	\$3.75
6	P751A018 3/4" Hose Barb - Plastic	1	\$2.50
7	P1012A017 1/2" N.P.T. Male Adapter - Plastic	1	\$3.00
8	P1008B012 1-1/2" Plug - PVC - Vented	1	\$13.75
9	P443A001 Toggle Switch - Single Pole	1	\$15.00
10	P461A006 Fuse Holder	1	\$12.75
11	P593A028 In Line Strainer	1	\$38.75
12	P593A032 Brass Cap	1	\$8.00
13	P596A002 Water Tank - Plastic - 50 Gallon	1	\$208.00
14	P713F000 3/4" Easy Couple Hose 300 psi [\$10.50/ft]	10 FT.	\$105.00
15	P1023A004 Worm Gear Clamp - #12 [\$3.25 ea]	2	\$6.50
16	P723G000 1/2" Black Heater Hose [\$3.75/ft.]	2 FT.	\$7.50
17	P1023A002 Worm Gear Clamp - #6 [\$2.00 ea]	2	\$4.00
18	P554A001 Terminal - Eye [\$1.50 ea]	5	\$7.50
19	P556A017 Wire - 14 GA GXL Red - 4 FT. section [\$1.00/ft]	2	\$8.00
20	P555A002 Butt Connector - 12-10 [\$1.75 ea]	2	\$3.50
21	P554A012 Ring Terminal - 12-10 GA	1	\$1.25
22	P555A001 Butt Connector - 16-14 GA [\$1.75 ea]	2	\$3.50
23	P595A012 Fuse - 15 AMP ATC	1	\$1.75
24	P443A004 Toggle Boot	1	\$14.00
25	P72000C119 Check Valve with Ball Valve Assembly	1	\$94.50
26	P50330A001 Tank Strap [\$136.25 ea]	2	\$272.50

EXTENDED DECK WATER SYSTEM KIT COMPLETE

EXTENDED DECK WATER SYSTEM KIT COMPLETE

PRODUCT #	DESCRIPTION	QTY	PRICE
P50330KED	Extended Deck Water System Kit Complete	1	\$746.00
1	P593A051 Water Pump - 12V DC	1	\$235.75
2	P1005A012 Nylon Tee - F x F x F - 1/2"	1	\$14.25
3	P1007A012 90° Nylon Street Elbow - 1/2"	1	\$9.75
4	P1000A084 1/2" Nipple - Nylon	1	\$2.00
5	P1010A044 3/4" x 1/2" Threaded Bushing Reducer PVC	1	\$3.75
6	P751A018 3/4" Hose Barb - Plastic	1	\$2.50
7	P1012A017 1/2" N.P.T. Male Adapter - Plastic	1	\$3.00
8	P1008B012 1-1/2" Plug - PVC - Vented	1	\$13.75
9	P443A001 Toggle Switch - Single Pole	1	\$15.00
10	P461A006 Fuse Holder	1	\$12.75
11	P593A028 In Line Strainer	1	\$38.75
12	P593A032 Brass Cap	1	\$8.00
13	P596A002 Water Tank - Plastic - 50 Gallon	1	\$208.00
14	P713F000 3/4" Easy Couple Hose 300 psi [\$10.50/ft]	10 FT.	\$105.00
15	P1023A004 Worm Gear Clamp - #12 [\$3.25 ea]	2	\$6.50
16	P723G000 1/2" Black Heater Hose [\$3.75/ft.]	2 FT.	\$7.50
17	P1023A002 Worm Gear Clamp - #6 [\$2.00 ea]	2	\$4.00
18	P554A001 Terminal - Eye [\$1.50 ea]	3	\$4.50
19	P556A017 Wire - 14 GA GXL Red - 4 FT. section [\$1.00/ft]	2	\$8.00
20	P555A002 Butt Connector - 12-10 [\$1.75 ea]	2	\$3.50
21	P554A012 Ring Terminal - 12-10 GA	1	\$1.25
22	P555A001 Butt Connector - 16-14 GA [\$1.75 ea]	2	\$3.50
23	P595A012 Fuse - 15 AMP ATC	1	\$1.75
24	P443A004 Toggle Boot	1	\$14.00
25	P72000C119 Check Valve with Ball Valve Assembly	1	\$94.50
26	P72000C104 Tank Angle Support	1	\$105.50
27	P422A006 Green Strap [\$10.50 ea]	2	\$21.00

AGITATION DRIVE KIT

575 Gallon & Under

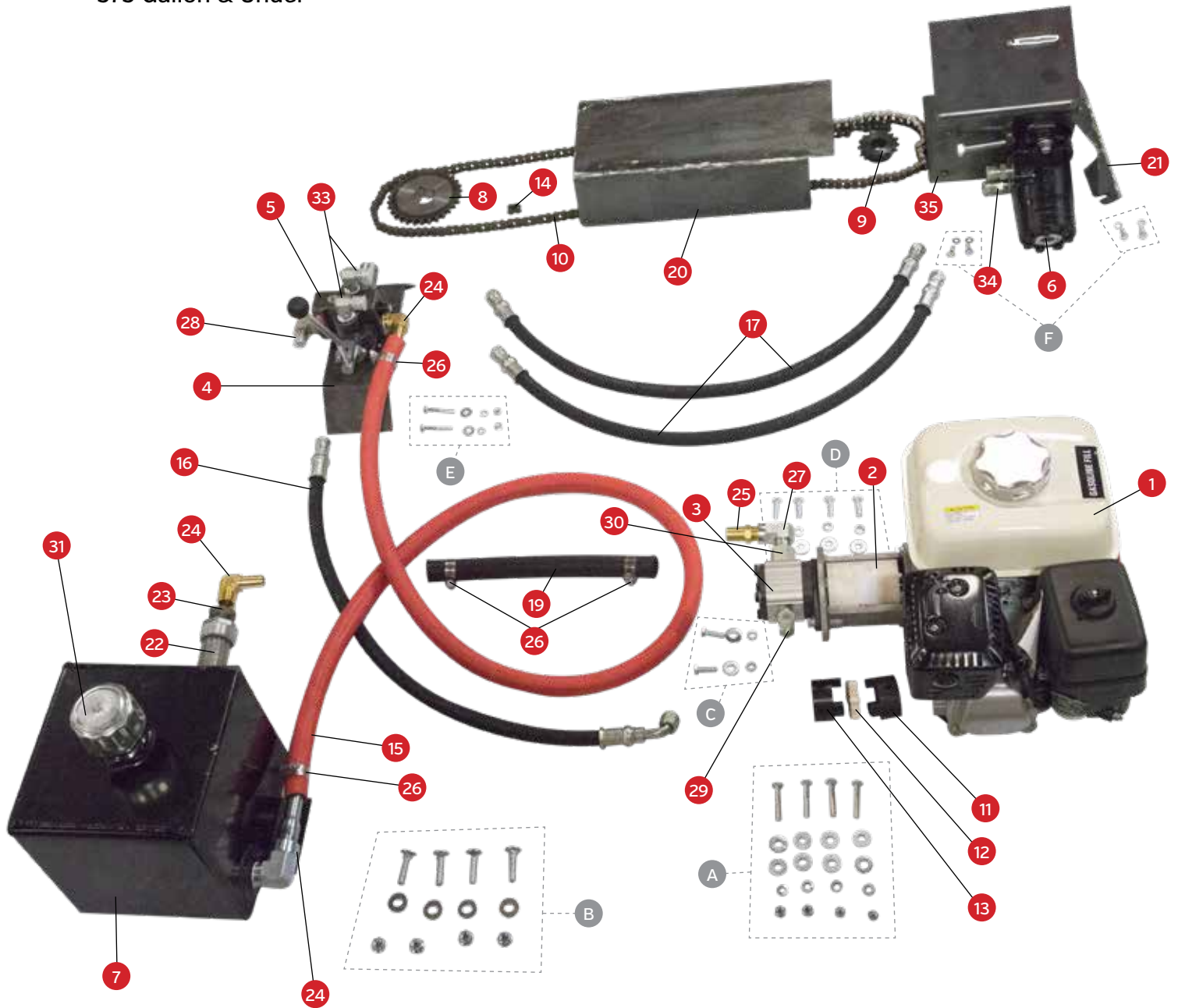

AGITATION DRIVE KIT (575 GAL & UNDER)

PRODUCT #	DESCRIPTION	QTY	PRICE
P50340C	Agitation Drive Kit - 575 & Under (176 lbs)	1	\$2,999.00
1	P458A022 Engine - Honda 5.5 HP	1	\$457.75
2	P604A018 Pump Mount	1	\$121.75
3	P601A041 Hydraulic Pump	1	\$265.75
4	P72000B013 Hydraulic Valve Bracket	1	\$47.75
5	P472A016 Hydraulic Valve	1	\$398.00
6	P474A088 Hydraulic Motor	1	\$512.50
7	P599A003 Hydraulic Tank	1	\$375.50
8	P426A011 40B30 Sprocket - 1-1/2" Bore x 1/2" Keyway	1	\$23.75
9	P426A001 40B15 Sprocket - 1" Bore x 1/4" Keyway	1	\$13.75
10	P1038A000 Single Strand Roller Chain #40 [\$4.00/ft.]	8 ft.	\$32.00
11	P630A035 Jaw Coupler L095 x 3/4" x 3/16"	1	\$18.50
12	P630A045 Jaw Coupler L095 x 1/2" x 1/8"	1	\$19.00
13	P631A005 Hytrel Insert	1	\$24.00
14	P1035A001 Spring Type Coupler Link #40	1	\$1.00
15	P713F000 3/4" Low Pressure Hose [\$10.50/ft.]	6 ft.	\$63.00
16	P702B030 30" Hydraulic H.P. Hose Assembly	1	\$83.50
17	P702B032 32" Hydraulic H.P. Hose Assembly [\$71.00 ea.]	2	\$142.00
18	P1020A030 1/2"-20 high Nut GR 8 Plain	1	\$1.25
19	P713E007.5 3/4" Black Suction Hose - 7-1/2"	1	\$8.50
20	P50000A005 Upper Chain Guard	1	\$54.75
21	P50000A006 Lower Chain Guard	1	\$95.00
22	P408A004 Tank Filter	1	\$38.75
23	P1010A009 1" x 3/4" Bushing Reducer	1	\$4.75
24	P751A020 90° Elbow 3/4" Hose Barb x 3/4" M NPT [\$14.50 ea.]	3	\$43.50
25	P751A003 3/4" Hose Barb x 1/2" M NPT	1	\$5.75
26	P1023A004 Hose Clamp #12 [\$3.25 ea.]	4	\$13.00
27	P560A016 1/2" Hydraulic 90° Street Elbow	1	\$10.75
28	P560A080 1/2" M JIC x 3/4" F NPT 90° Hydraulic Elbow	1	\$19.25
29	P569A005 1/2" M JIC x 3/8" O-Ring 90° Hydraulic Elbow	1	\$6.00
30	P570A008 1/2" O-Ring x 1/2" F NPT Hydraulic Connector	1	\$6.75
31	P1050A006 Threaded Filler Breather - 1"	1	\$38.25
32	P1015A031 1/2" - 20 Set Screw Fine	1	\$6.75
33	P565A004 1/2" M JIC x 1/2" M NPT 90° Hydraulic Elbow [\$6.00 ea]	2	\$12.00
34	P567A013 1/2" M JIC x 1/2" M NPT Hydraulic Adapter [\$3.25 ea]	2	\$6.50
35	P50000A002 Motor Mount	1	\$284.50
A	P50340HK001 Hardware Kit - Engine Hold Down	1	\$2.25
B	P50340HK002 Hardware Kit - Hydraulic Tank Hold Down	1	\$3.75
C	P50340HK003 Hardware Kit - Hydraulic Pump to Pump Mount	1	\$1.25
D	P50340HK004 Hardware Kit - Pump Mount to Engine	1	\$2.25
E	P50340HK005 Hardware Kit - Valve to Valve Mount	1	\$1.25
F	P50340HK006 Hardware Kit - Both Guards [\$.75 ea]	2	\$1.50

AGITATION DRIVE KIT

750 to 1500 Gallon

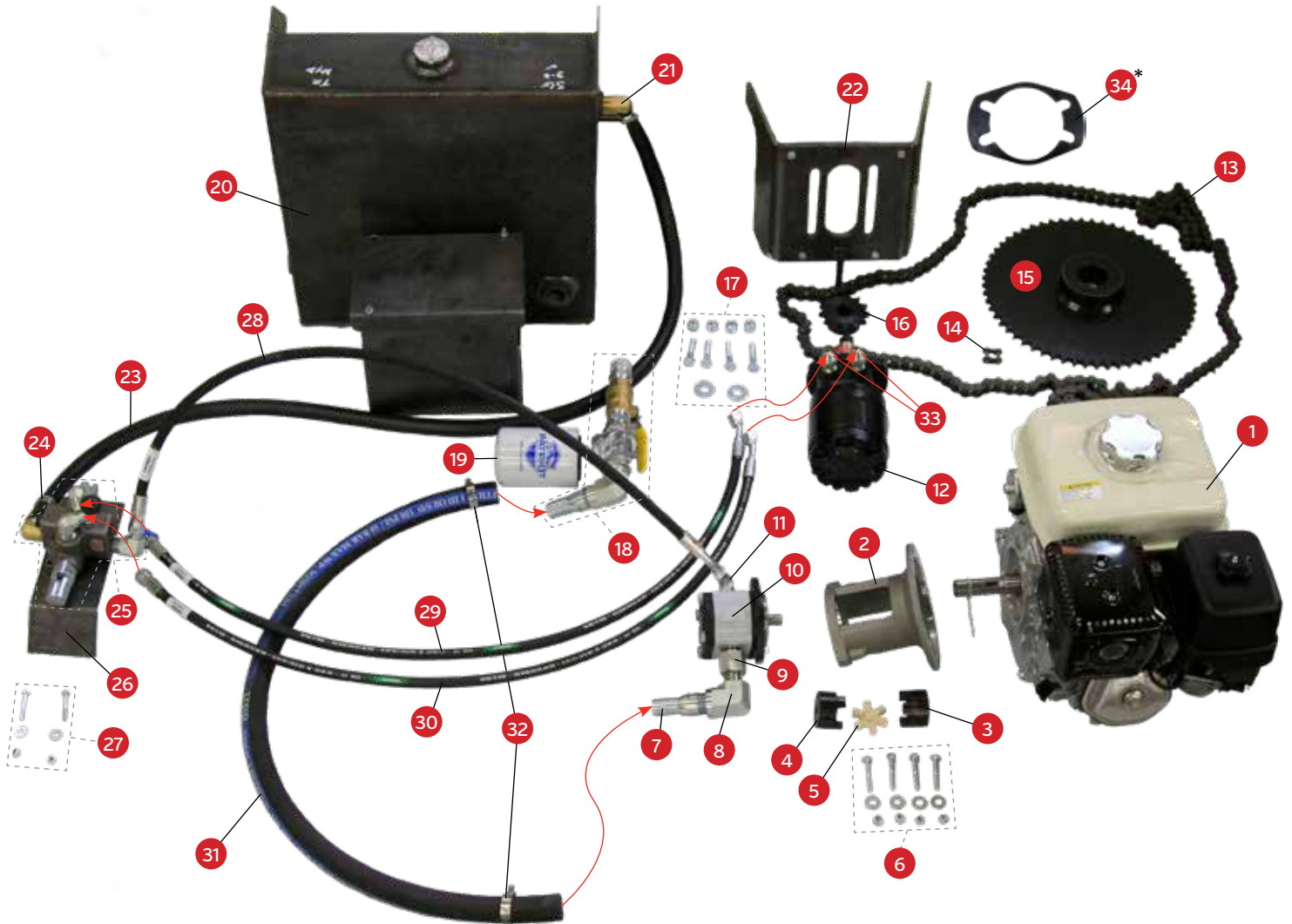

*Picture is larger than actual part

AGITATION DRIVE KIT (750-1500 GAL)

PRODUCT #	DESCRIPTION	QTY	PRICE
P50340D	Agitation Drive Kit - 750-1500 Gallon	1	\$4,999.00
1 P458A050	Engine - Honda GX240 - Electric Start	1	\$1,142.50
2 P604A010	Pump Mount	1	\$122.25
3 P630A032	Jaw Coupler L095 x 1" x 1/4"	1	\$14.75
4 P630A031	Jaw Coupler L095 x 5/8" x 5/32"	1	\$30.25
5 P631A005	Hytrex Insert	1	\$24.00
6 P50340HK001	Hardware Kit - Engine Hold Down	1	\$2.25
7 P1012A004	1" Hose Adapter	1	\$9.25
8 P560A053	90° Hydraulic Street Elbow - 3/4" M NPT x 1" F NPT	1	\$23.75
9 P570A001	Hydraulic Connector - 5/8" O-Ring x 3/4" F NPT	1	\$13.50
10 P601A014	Hydraulic Pump for Pro-Air & Maxi Air 750 & up	1	\$465.00
11 P569A003	90° Hydraulic Elbow - 1/2" M JIC x 5/8" O-Ring	1	\$9.00
12 P474A017	Hydraulic Motor	1	\$1,071.00
13 P1040A000	Single Strand Roller Chain #60 [\$7.75 per ft.]	10 ft.	\$77.50
14 P1035A003	Spring Type Coupler Link #60	1	\$2.00
15 P428A003	Sprocket 60B60 - 2" Bore x 1/2" Keyway	1	\$199.00
16 P428A001	Sprocket 60B15 - 1-1/4" Bore x 5/16" Keyway	1	\$41.75
17 P50340HK007	Hardware Kit - Motor Mount	1	\$9.25
18 P72000R005	Hydraulic Plumbing Sub Assembly - 1" Filter Head	1	\$134.75
19 P908A003	Oil Filter	1	\$14.00
20 P72000B105	Hydraulic Tank with Battery Box	1	\$579.00
21 P751A020	90° Elbow 3/4" Hose Barb x 3/4" M NPT	1	\$14.50
22 P50107F004	Hydraulic Motor Mount Weldment	1	\$232.00
23 P713F000	3/4" Hose - Low Pressure [\$10.50/ft.]	6 ft.	\$63.00
24 P1023A004	Hose Clamp #12 [\$3.25 ea.]	2	\$6.50
25 P72000R006	Control Valve Assembly	1	\$462.00
26 P72000B013	Hydraulic Valve Bracket	1	\$47.75
27 P50340HK005	Hardware Kit - Valve to Valve Mount	1	\$1.25
28 P50186B002	Control Valve Hose	1	\$87.50
29 P50186B001	Agitator Motor Hose	1	\$89.25
30 P50186B001	Agitator Motor Hose	1	\$89.25
31 P715B048	1" Nitrile Petroleum Suction Hose - 48"	1	\$35.75
32 P1023A005	Hose Clamp #16" [\$2.75 ea.]	2	\$5.50
33 P567A006	Hydraulic Fitting - 1/2" M JIC x 5/8" O-Ring [\$3.00 ea]	2	\$6.00
34 P50227D	Motor Plate	1	\$21.75

CP STROBE LIGHT KIT



CP STROBE LIGHT KIT

PRODUCT #	DESCRIPTION	QTY	PRICE
P50281KCS	CP Strobe Light Kit Complete	1	\$347.75
Specify What Color it Needs to be Painted When Ordering			
A	P74000C436 Strobe Light Mount Assembly	1	\$240.50
B	P516A035 L.E.D. Strobe Light	1	\$81.25
C	P461A006 In-Line Fuse Holder - 30 AMP	1	\$12.75
D	P556A017 Wire - 14 GA GXL - Red	1 ft.	\$1.00
E	P595A008 Fuse - 10 AMP ATC	1	\$5.00
F	P554A001 Ring Terminal 16-14 GA - #10 Stud [\$1.50 ea.]	3	\$4.50
G	P554A009 Ring Terminal 12-10 GA - #10 Stud	1	\$1.00
H	P555A003 Step Down Butt Splice - 12-10 GA to 16-14 GA	1	\$3.75
I	P475C001 Cable Tie [\$.25 ea.]	10	\$2.50
J	P443A001 Toggle Switch - Single Pole	1	\$15.00
K	P1017A002 Flat Washer - 5/16" [\$.25 ea.]	8	\$2.00
L	P1018A002 Lock Washer - 5/16" [\$.25 ea.]	4	\$1.00
M	P1020A003 Hex Nut - 5/16"-18 [\$.25 ea.]	4	\$1.00
N	P1014A010 Capscrew 5/16"-18 x 1 1/4" [\$.50 ea.]	4	\$2.00
O	P1014A001 Capscrew 1/4"-20 x 1" [\$.25 ea.]	2	\$0.50
P	P1017A001 Flat Washer - 1/4" [\$.25 ea.]	2	\$0.50
Q	P1018A001 Lock Washer - 1/4" [\$.25 ea.]	2	\$0.50
R	P443A004 Toggle Boot	1	\$14.00

CP 125HH ARROWBOARD LIGHT & MOUNT KIT

For Crack Pros without Arrowboard and Mount Already Installed

CP 125HH ARROWBOARD LIGHT & MOUNT KIT

PRODUCT #	DESCRIPTION	QTY	PRICE
P74000C303K	CP 125HH Arrowboard Light & Mount Kit	1	\$2,081.25
Specify What Color it Needs to be Painted When Ordering			
1	P516A033 Arrowboard	1	\$1,605.75
2	P74000C433 CP 125HH Arrowboard Light Mount Assembly	1	\$419.75
3	P443A001 Toggle Switch - Single Pole	1	\$15.00
4	P443A004 Toggle Boot	1	\$14.00
5	P461A006 In-Line Fuse Holder - 30 AMP	1	\$12.75
6	P555A001 Butt Connector - 16-14 GA [\$1.75 ea.]	2	\$3.50
7	P555A003 Step Down Butt Splice - 12-10 GA to 16-14 GA	1	\$3.75
8	P554A001 Ring Terminal 16-14 GA [\$1.50 ea.]	3	\$4.50
9	P554A009 Ring Terminal 12-10 GA - #10 Stud	1	\$1.00
10	P747A001 Polyloom - 3/8" [\$1.75/ft.]	8 ft.	\$14.00
11	P475C006 Cable Tie - 8" [\$0.25 ea.]	6	\$1.50
12	P595A012 Fuse - 15 AMP ATC	1	\$1.75
13	P556A017 Wire - 14 GA GXL - Red [\$1.00/ft.]	10	\$10.00
14	P556A016 Wire - 14 GA GXL - Black [\$1.00/ft.]	8	\$8.00
15	P1014A057 Cap Screw - 1.4"-20 x 3/4" [\$0.25 ea.]	4	\$1.00
P74000C303K and P74000C307K Together			
P74000C304K	CP 125HH Arrowboard & Strobe Light with Mounts	1	\$2,314.25

CP 260/400HH ARROWBOARD LIGHT & MOUNT KIT

For Crack Pros without Arrowboard and Mount Already Installed

CP 260/400HH ARROWBOARD LIGHT & MOUNT KIT

PRODUCT #	DESCRIPTION	QTY	PRICE
P74000C305K	CP 260/400HH Arrowboard Light & Mount Kit	1	\$2,073.75
Specify What Color it Needs to be Painted When Ordering			
1	P516A033 Arrowboard	1	\$1,605.75
2	P74000C435 CP 260/400HH Arrowboard Light Mount Assembly	1	\$447.75
3	P443A001 Toggle Switch - Single Pole	1	\$15.00
4	P443A004 Toggle Boot	1	\$14.00
5	P461A006 In-Line Fuse Holder - 30 AMP	1	\$12.75
6	P555A001 Butt Connector - 16-14 GA [\$1.75 ea.]	2	\$3.50
7	P555A003 Step Down Butt Splice - 12-10 GA to 16-14 GA	1	\$3.75
8	P554A001 Ring Terminal 16-14 GA [\$1.50 ea.]	3	\$4.50
9	P554A009 Ring Terminal 12-10 GA - #10 Stud	1	\$1.00
10	P747A001 Polyloom - 3/8" [\$1.75/ft.]	8 ft.	\$14.00
11	P475C006 Cable Tie - 8" [\$.25 ea.]	6	\$1.50
12	P595A012 Fuse - 15 AMP ATC	1	\$1.75
13	P556A017 Wire - 14 GA GXL - Red [\$1.00/ft.]	10	\$10.00
14	P556A016 Wire - 14 GA GXL - Black [\$1.00/ft.]	8	\$8.00
15	P1014A057 Cap Screw - 1/4"-20 x 3/4" [\$.25 ea.]	4	\$1.00
P74000C305K and P74000C307K Together			
P74000C306K	CP 260/400HH Arrowboard & Strobe Light with Mounts	1	\$2,338.00

CP MACHINES STROBE LIGHT & ATTACHMENT KIT

For Crack Pros with Arrowboard and Mount Already Installed

CP MACHINES STROBE LIGHT & ATTACHMENT KIT

PRODUCT #	DESCRIPTION	QTY	PRICE
P74000C307K	CP Machines Strobe Light and Attachment Kit	1	\$295.50
Specify What Color it Needs to be Painted When Ordering			
A	P74000C434 Strobe Light Attachment	1	\$187.00
B	P516A035 L.E.D. Strobe Light	1	\$81.25
C	P461A006 In-Line Fuse Holder - 30 AMP	1	\$12.75
D	P595A008 Fuse - 10 AMP ATC	1	\$5.00
E	P554A001 Ring Terminal 16-14 GA [\$1.50 ea.]	3	\$4.50
F	P554A009 Ring Terminal 12-10 GA - #10 Stud	1	\$1.00
G	P555A003 Step Down Butt Splice - 12-10 GA to 16-14 GA	1	\$3.75
H	P475C001 Cable Tie - 8" [\$.25 ea.]	10	\$2.50
I	P443A001 Toggle Switch - Single Pole	1	\$15.00
J	P443A004 Toggle Boot	1	\$14.00
K	P1017A002 Flat Washer - 5/16" [\$.25 ea.]	8	\$2.00
L	P1018A002 Lock Washer - 5/16" [\$.25 ea.]	4	\$1.00
M	P1020A003 Hex Nut - 5/16"-18 [\$.25 ea.]	4	\$1.00
N	P1014A010 Cap Screw - 5/16"-18 x 1-1/4" [\$.50 ea.]	4	\$2.00
O	P1014A001 Cap Screw - 1/4"-20 x 1" [\$.25 ea.]	2	\$0.50
P	P1017A001 Flat Washer - 1/4" [\$.25 ea.]	10	\$2.50
Q	P1018A001 Lock Washer - 1/4" [\$.25 ea.]	2	\$0.50
R	P1021A006 Lock Nut - 1/4"-20 [\$.25 ea.]	4	\$1.00
S	P556A017 Wire - 14 GA GXL - Red	1	\$1.00

CRACK PRO COUNTER BALANCE HOSE BOOM KIT

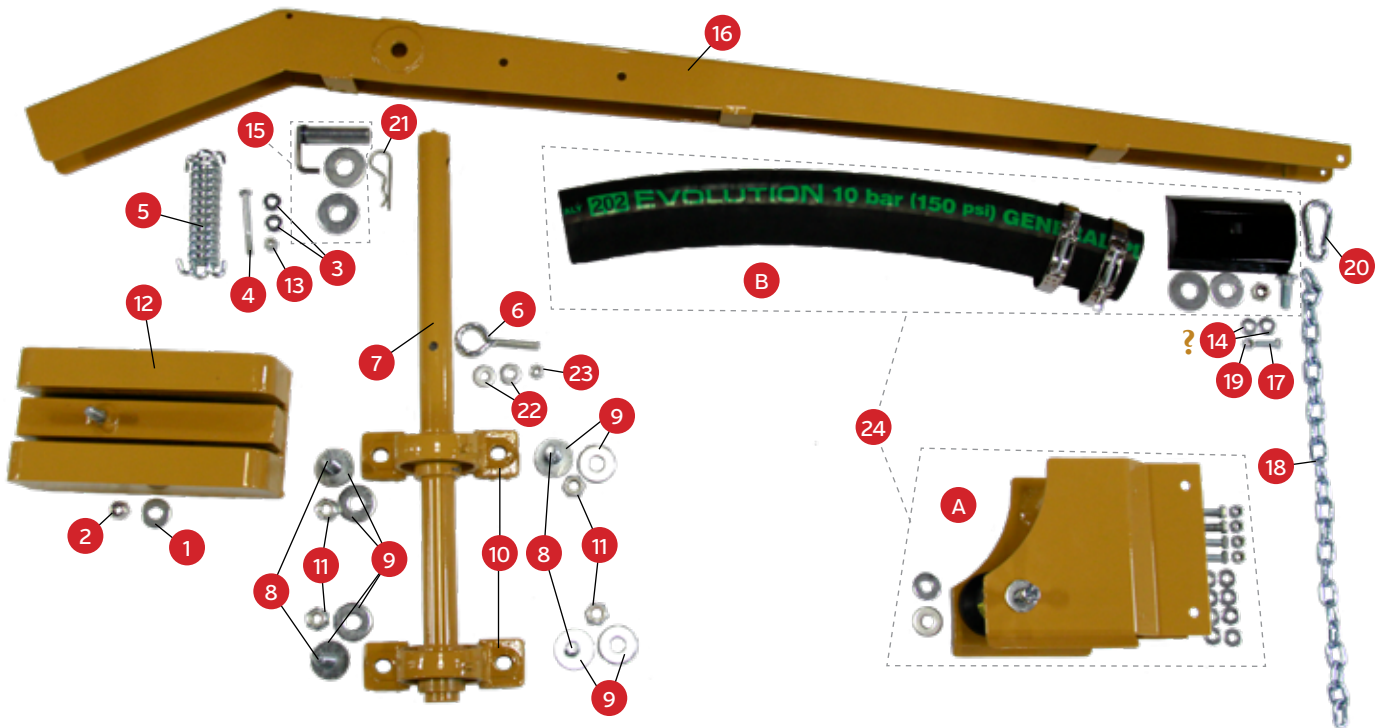

CRACK PRO COUNTER BALANCE HOSE BOOM KIT

PRODUCT #	DESCRIPTION	QTY	PRICE
P74000J007	CP Counter Balance Hose Boom Kit	1	\$1,575.00
Specify What Color it Needs to be Painted When Ordering			
1	P1017A005	Flat Washer - 1/2"	\$0.50
2	P1021A002	Locknut - 1/2"-13	\$0.50
3	P1017A002	Flat Washer - 5/16" (\$.25 ea.)	\$1.00
4	P1014A014	Capscrew - 5/16"-18 x 3"	\$1.50
5	P589A010	Spring	\$11.50
6	P1031A001	Eye Bolt - 3/8"-16 x 4"	\$4.00
7	P74000J015	Boom Pivot Shaft	\$42.25
8	P1014A040	Capscrew - 5/8"-11 x 2" [\$2.25 ea.]	\$9.00
9	P1017A007	Flat Washer - 5/8" (\$.75 ea.)	\$6.00
10	P435A004	Pillow Block Bearing - 1-1/2" [\$32.25 ea.]	\$64.50
11	P1021A014	Locknut - 5/8"-11 [\$1.00 ea.]	\$4.00
12	P74000J017	Boom Counter Weight Assembly	\$698.00
13	P1021A005	Locknut - 5/16"-18	\$0.25
14	P1017A008	Flat Washer - 3/4" (\$.75 ea.)	\$1.50
15	P74000J022	Clevis Pin with Bar	\$47.25
16	P74000J018	Boom Weldment	\$343.25
17	P1014A009	Capscrew - 5/16"-18 x 1"	\$0.50
18	P531A002	Chain- 3/16" Wide Link [\$4.00/ft.]	3 ft. \$12.00
19	P1020A003	Hex Nut - 5/16"-18	\$0.25
20	P531A007	Spring Snap - 7/16"	\$6.50
21	P1034A022	Hitch Pin - 5/32" x 2-15/16"	\$1.50
22	P1017A003	Flat Washer - 3/8"	\$0.25
23	P1021A001	Locknut - 3/8"-16 (\$.25 ea.)	\$1.25
24	P74000L006	Hose Guide and End Support Kit	\$355.75
P74000L006 Consists of:			
A	P74000J006	Boom Hose Guide Kit	\$223.25
B	P74000M006	Boom Hose End Support Kit	\$132.50

CRACK PRO HOSE GUIDE KIT

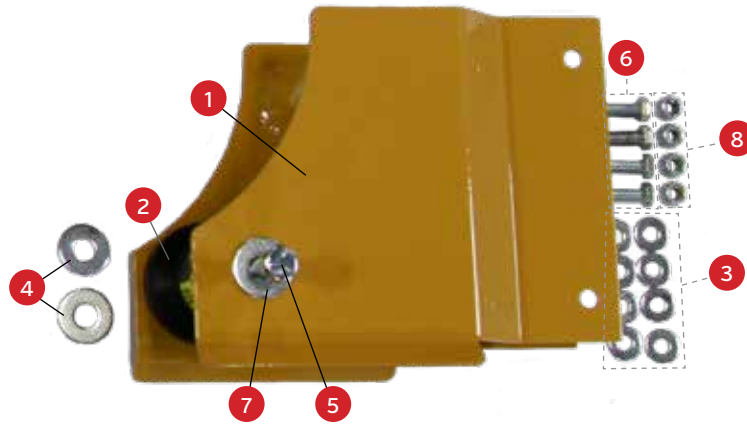

PRODUCT #	DESCRIPTION	QTY	PRICE
P74000J006	Boom Hose Guide Kit	1	\$223.25
Specify What Color it Needs to be Painted When Ordering			
1	P74000J004 Boom Hose Guide	1	\$193.50
2	P74000J003 Spool Roller	1	\$24.75
3	P1017A003 Flat Wahser - 3/8" [\$0.25 ea.]	8	\$2.00
4	P1017A005 Flat Washer - 1/2" [\$0.50 ea.]	2	\$1.00
5	P1014A170 Capscrew - 1/2"-13 x 6-1/2"	1	\$3.75
6	P1014A017 Capscrew - 3/8"-16 x 1" [\$0.50 ea.]	4	\$2.00
7	P1021A002 Locknut - 1/2"-13	1	\$0.50
8	P1021A001 Locknut - 3/8"-16 [\$0.25 ea.]	4	\$1.00

CRACK PRO END SUPPORT KIT



PRODUCT #	DESCRIPTION	QTY	PRICE
P74000M006	Boom Hose End Support Kit	1	\$132.50
Specify What Color it Needs to be Painted When Ordering			
1	P1017A005 Flat Washer - 1/2"	1	\$0.50
2	P1017A008 Flat Washer - 3/4"	1	\$0.75
3	P1020A005 Hex Nut - 1/2"-13	1	\$0.25
4	P1023A013 Bolt Clamp - 4-3/32" [\$8.50 ea.]	2	\$17.00
5	P74000J023 Hose End Support Plate	1	\$85.50
6	P1019A012 Carriage Bolt - 1/2"-13 x 2"	1	\$1.25
7	P482B028 3" Suction Hose x 28"	1	\$39.75

CRACK PRO SIDE CHAIR COMPLETE ASSEMBLY

PRODUCT #	DESCRIPTION	QTY	PRICE
P74000B406	Crack Pro Side Chair Complete Assembly	1	\$3,529.75
1 P553A020	Hitch Receiver Tube [\$52.75 ea.]	2	\$105.50
2 P74000B408	Tube Bracket Mount - Right Side	1	\$39.50
3 P74000C405	Chair Mount and Arm Rest	1	\$2,702.25
4 P74000C406	Hitch Mount Assembly	1	\$527.25
5 P74000B409	Tube Bracket Mount - Left Side	1	\$39.50
6 P74000C407	Tightening Handle [\$28.75 ea.]	2	\$57.50
7 P602A003	Seat	1	\$114.25
8 P1017A002	Flat Washer - 5/16" (\$.25 ea.)	4	\$1.00
9 P1018A002	Lock Washer - 5/16" (\$.25 ea.)	4	\$1.00
10 P1014A009	Hex Head Cap Screw - 5/16"-18 x 1" (\$.50 ea.)	4	\$2.00